



# International Exchange Framework for Mandatory Disclosure Rules on CRS Avoidance Arrangements and Opaque Offshore Structures

June 2019

# **International Exchange Framework for Mandatory Disclosure Rules on CRS Avoidance Arrangements and Opaque Offshore Structures**

This document and related XML Schema, as well as any data and any map included herein, are without prejudice to the status of or sovereignty over any territory, to the delimitation of international frontiers and boundaries and to the name of any territory, city or area.

This document was approved by the Committee on Fiscal Affairs on 5 April 2019 and prepared for publication by the OECD Secretariat.

**Please cite this publication as:**

OECD (2019), *International Exchange Framework for Mandatory Disclosure Rules on CRS Avoidance Arrangements and Opaque Offshore Structures*, OECD, Paris.

[www.oecd.org/tax/exchange-of-information/international-exchange-framework-for-mandatory-disclosure-rules-on-crs-avoidance-arrangements-and-opaque-offshore-structure.pdf](http://www.oecd.org/tax/exchange-of-information/international-exchange-framework-for-mandatory-disclosure-rules-on-crs-avoidance-arrangements-and-opaque-offshore-structure.pdf)

The statistical data for Israel are supplied by and under the responsibility of the relevant Israeli authorities. The use of such data by the OECD is without prejudice to the status of the Golan Heights, East Jerusalem and Israeli settlements in the West Bank under the terms of international law.

**Note by Turkey**

The information in the related XML Schema with reference to “Cyprus” relates to the southern part of the Island. There is no single authority representing both Turkish and Greek Cypriot people on the Island. Turkey recognises the Turkish Republic of Northern Cyprus (TRNC). Until a lasting and equitable solution is found within the context of the United Nations, Turkey shall preserve its position concerning the “Cyprus issue”.

**Note by all the European Union Member States of the OECD and the European Union**

The Republic of Cyprus is recognised by all members of the United Nations with the exception of Turkey. The information in the related XML Schema relates to the area under the effective control of the Government of the Republic of Cyprus.

**Photo credits:** Cover © tj-rabbit/Shutterstock.com.

© OECD 2019

---

You can copy, download or print OECD content for your own use, and you can include excerpts from OECD publications, databases and multimedia products in your own documents, presentations, blogs, websites and teaching materials, provided that suitable acknowledgement of OECD as source and copyright owner is given. All requests for public or commercial use and translation rights should be submitted to [rights@oecd.org](mailto:rights@oecd.org).

---

*Table of contents*

<b>Introduction .....</b>	<b>5</b>
<b>Part I – Draft Multilateral Competent Authority Agreement on the Automatic Exchange regarding CRS Avoidance Arrangements and Opaque Offshore Structure .....</b>	<b>7</b>
<b>Part II – MDR XML Schema and User Guide .....</b>	<b>13</b>
<b>MDR XML Schema Information .....</b>	<b>16</b>
<b>Appendix A - MDR XML Schema Diagrams .....</b>	<b>43</b>
<b>Appendix B - Glossary of Namespaces .....</b>	<b>54</b>



## Introduction

1. Following the approval of the Model Mandatory Disclosure Rules (MDRs) by the OECD's Committee on Fiscal Affairs and their release on 8 March 2018, Working Party No. 10 has developed the legal and technical information exchange infrastructure that is needed for the exchange of the information collected by tax administrations under the MDRs.

2. This note therefore sets out the international framework that would govern these exchanges, both from a legal and an operational perspective.

3. **Part I** of this note contains a draft multilateral Competent Authority Agreement for the exchange of MDR reports that has been modelled on the CRS MCAA.

4. In drafting the MCAA, an automatic exchange approach has been adopted, following the approach used for the CRS and CbC exchanges. This has been done in order to ensure that exchanges will be operationalised on the clear and unambiguous legal basis of Article 6 of the Convention and to provide clarity about the scope and periodicity of the exchanged information. The approach in the draft MCAA with respect to the information flows is that exchanges in principle are on a reciprocal basis between two jurisdictions that have implemented MDRs. This has the advantage that only jurisdictions that are familiar with the MDR and thus have a better understanding of the information will be receiving the information. It also provides an incentive for jurisdictions to adopt MDR to benefit from the automatic exchange network.

5. The basic premise for the automatic exchange flows under the draft MCAA is that a jurisdiction that received information about a CRS Avoidance Arrangement or Opaque Offshore Structure under the MDRs would exchange such information with all jurisdictions of tax residence of the Reportable Taxpayer(s), which are other MDR implementing jurisdictions and are signatories to the MCAA. This will allow tax authorities of such jurisdictions to use such information to carry out compliance activities permitted under the Convention with respect to such Reportable Taxpayers.

6. At the same time, the mandatory disclosure rules and the reciprocal automatic exchange contemplated by the draft MCAA will provide tax authorities information, which can be used to inform and foster their compliance activities in a collaborative manner. For instance, in addition to actions with respect to Reportable Taxpayers identified in the MDR reports, authorities may also consider:

- exchanging information on intermediaries with other jurisdictions, where it is reasonable to suspect that such intermediaries have offered their services to taxpayers in such jurisdictions;
- initiating further compliance activities with respect to the Intermediaries identified;
- addressing group requests to the jurisdiction where the Intermediary is resident, in order to obtain information on other taxpayers that have relied on the services of the Intermediary (e.g. in case a particular Intermediary resident in another jurisdiction is identified in the MDR reports on multiple occasions);

- carrying out coordinated compliance activities through the JITSIC network or other similar platforms.
7. To highlight such activities, the preamble of the MCAA addresses the possibility of enhanced co-operation between the Competent Authorities.
8. Separately from the exchange of information under this MDR MCAA, it is expected that tax authorities will also share generic intelligence they obtain on CRS Avoidance Arrangements or Opaque Offshore Structures pursuant to their domestic MDRs. The Secretariat could facilitate this by establishing a directory of such Arrangements and Structures, similar to the existing ATP Directory containing aggressive tax avoidance schemes.
9. **Part II** of the note contains the XML Schema and User Guide to support MDR exchanges, taking into account the information that is to be disclosed under Sections 2.1 and 2.3 of the MDRs.

## **Part I – Draft Multilateral Competent Authority Agreement on the Automatic Exchange regarding CRS Avoidance Arrangements and Opaque Offshore Structure**

Whereas, the jurisdictions of the signatories to the Multilateral Competent Authority Agreement on the Automatic Exchange regarding CRS Avoidance Arrangements and Opaque Offshore Structures (the “Agreement”) are Parties of, or territories covered by, the Convention on Mutual Administrative Assistance in Tax Matters or the Convention on Mutual Administrative Assistance in Tax Matters as amended by the Protocol amending the Convention on Mutual Administrative Assistance in Tax Matters (the “Convention”);

Whereas, the jurisdictions intend to further improve international tax compliance by building on their relationship with respect to mutual assistance in tax matters, in particular the automatic exchange of financial account information pursuant to the Common Reporting Standard and by means of the Multilateral Competent Authority Agreement on Automatic Exchange of Financial Account Information;

Whereas exchanges under the Common Reporting Standard have now commenced amongst the over 100 committed jurisdictions, demonstrating a major shift in international tax transparency and strengthening the ability of jurisdictions to tackle offshore tax evasion;

Whereas there may be cases where professional advisers and other intermediaries continue to design, market or assist in the implementation of offshore structures and arrangements that can be used by non-compliant taxpayers to circumvent the correct reporting of relevant information to the tax administration of their jurisdiction of residence, including under the Common Reporting Standard;

Whereas, against this background, G7 Finance Ministers on 13 May 2017 issued the Bari Declaration, calling on the OECD to start “discussing possible ways to address arrangements designed to circumvent reporting under the Common Reporting Standard or aimed at providing beneficial owners with the shelter of non-transparent structures”;

Whereas, the Model Mandatory Disclosure Rules were developed by the OECD in response to that call in order to provide tax administrations with information on CRS Avoidance Arrangements and Opaque Offshore Structures, including the users of those arrangements and those involved with their supply, for compliance purposes, to inform future tax policy design, as well as to have a deterrent effect on advisors and other intermediaries against the design, marketing, assistance in the implementation and use of such arrangement, therewith bolstering the overall integrity of the Common Reporting Standard;

Whereas, the laws of the respective Jurisdictions require or are expected to require the disclosure of CRS Avoidance Arrangements and Opaque Offshore Structures, consistent with the scope of exchange contemplated by Section 2 of this Agreement, the Model Mandatory Disclosure Rules and Section IX of the Common Reporting Standard;

Whereas, in instances where such information relates to a Reportable Taxpayer that is resident in one or more other Jurisdictions, it is contemplated that such information is



exchanged with the tax administration of that jurisdiction in accordance with the terms of the applicable international legal instrument;

Whereas, Chapter III of the Convention authorises the exchange of information for tax purposes, including the exchange of information on an automatic basis, and Article 6 of the Convention allows the competent authorities of the Jurisdictions to agree the scope and modalities of such automatic exchanges, such exchanges of the information between Competent Authorities taking place on a bilateral basis;

Whereas, the Jurisdictions have in place by the time the first exchange takes place (i) appropriate safeguards to ensure that the information received pursuant to this Agreement remains confidential and is used solely for the purposes set out in the Convention, and (ii) the infrastructure for an effective exchange relationship;

Whereas, the Competent Authorities of the jurisdictions intend to conclude an agreement to gather further intelligence and improve on international tax compliance based on automatic exchange pursuant to the Convention, without prejudice to national legislative procedures (if any), respecting EU law (if applicable), and subject to the confidentiality and other protections provided for in the Convention, including the provisions limiting the use of the information exchanged thereunder;

Whereas, the Competent Authorities intend to collaborate and assist each other using the forms of assistance permitted under the Convention to make the most effective use of the information obtained under applicable domestic mandatory disclosure rules for CRS Avoidance Arrangements and Opaque Offshore Structures;

Now, therefore, the Competent Authorities have agreed as follows:

## **SECTION 1** **Definitions**

1. For the purposes of this Agreement, the following terms have the following meanings:
  - a) the term “Jurisdiction” means a country or a territory in respect of which the Convention is in force and is in effect, either through signature and ratification in accordance with Article 28, or through territorial extension in accordance with Article 29, and which is a signatory to this Agreement;
  - b) the term “Competent Authority” means, for each respective Jurisdiction, the persons and authorities listed in Annex B of the Convention;
  - c) the term “Reportable Arrangement” means a CRS Avoidance Arrangement or Opaque Offshore Structure that has been disclosed in the Jurisdiction under its Mandatory Disclosure Rules with respect to which one or more persons that are Reportable Taxpayers have been identified;
  - d) the term “Reportable Taxpayer” means, in respect of a CRS Avoidance Arrangement, any actual or potential user of that Arrangement and, in respect of an Opaque Offshore Structure, a natural person whose identity as a Beneficial Owner cannot be accurately determined due to the Opaque Offshore Structure;
  - e) the term “Model Mandatory Disclosure Rules” means the model mandatory disclosure rules for CRS Avoidance Arrangements and Opaque Offshore Structures, published by the OECD in March 2018;

- f) the term “Co-ordinating Body Secretariat” means the OECD Secretariat that, pursuant to paragraph 3 of Article 24 of the Convention, provides support to the co-ordinating body that is composed of representatives of the competent authorities of the Parties to the Convention;
- g) the term “Agreement in effect” means, in respect of any two Competent Authorities, that both Competent Authorities have indicated their intention to automatically exchange information with each other and have satisfied the other conditions set out in paragraph 2 of Section 6;
- h) the term “Mandatory Disclosure Rules” means the implementing legislation of the Jurisdiction applying the Agreement, such legislation being consistent with the Model Mandatory Disclosure Rules.
2. Any capitalised term not otherwise defined in this Agreement will have the meaning that it has at that time under the Mandatory Disclosure Rules of the Jurisdiction applying the Agreement. Any term not otherwise defined or referenced in this Agreement or in the Model Mandatory Disclosure Rules will, unless the context otherwise requires or the Competent Authorities agree to a common meaning (as permitted by domestic law), have the meaning that it has at that time under the law of the Jurisdiction applying this Agreement, any meaning under the applicable tax laws of that Jurisdiction prevailing over a meaning given to the term under other laws of that Jurisdiction.

## SECTION 2

### Exchange of Information with Respect to Reportable Arrangements

1. Pursuant to the provisions of Articles 6 and 22 of the Convention and subject to the applicable Mandatory Disclosure Rules, each Competent Authority will exchange with the Competent Authority(ies) of the Jurisdiction(s) where the Reportable Taxpayer is resident for tax purposes, with respect to which it has this Agreement in effect, on an automatic basis the information obtained pursuant to such rules and specified in paragraph 3.
2. Notwithstanding the previous paragraph, the Competent Authorities of the Jurisdictions that have indicated that they are to be listed as non-reciprocal jurisdictions on the basis of their notification pursuant to subparagraph 1(b) of Section 6 will send the information set out in paragraph 3, but will not receive such information under this Agreement.
3. The information to be exchanged is with the Jurisdiction(s) of tax residence of a Reportable Taxpayer with respect to a Reportable Arrangement is:
- a) the name and address, of the following persons:
    - the person making the disclosure;
    - the Reportable Taxpayer, including the jurisdiction(s) and TIN(s) of tax residence and the date of birth;
    - any person that is an Intermediary with respect to that Arrangement or Structure (other than the person making the disclosure), including each such Intermediary’s jurisdiction(s) of tax residence.
  - b) the details of that CRS Avoidance Arrangement or Opaque Offshore Structure including;

- in respect of a CRS Avoidance Arrangement, a factual description of those features of the Arrangement that are designed to have, marketed as having, or have the effect of, circumventing the CRS Legislation;
  - in respect of an Opaque Offshore Structure, a factual description of those features that have the effect of not allowing the accurate determination of the Reportable Taxpayer's Beneficial Ownership or creating the appearance that the Reportable Taxpayer is not a Beneficial Owner of the Passive Offshore Vehicle; and
- c) the jurisdiction or jurisdictions where the CRS Avoidance Arrangement or Opaque Offshore Structure has been made available for implementation.

to the extent such information was within the knowledge, possession or control of the person providing the disclosure and reflecting the content of the disclosure made by the Intermediary to the sending Competent Authority.

### **SECTION 3**

#### **Time and Manner of Exchange of Information**

1. With respect to paragraph 3 of Section 2, and subject to the notification procedure set out in Section 6, including the dates specified therein, information with respect to a Reportable Arrangement is to be exchanged by a Competent Authority within three months of the end of the quarter in which the information regarding the Reportable Arrangement was disclosed to that Competent Authority.
2. Notwithstanding paragraph 1, information is only required to be exchanged as from the date on which both Competent Authorities have this Agreement in effect and their respective Jurisdictions have Mandatory Disclosure Rules in effect.
3. The Competent Authorities will automatically exchange the information described in Section 2 in a common schema in Extensible Markup Language. The information will be exchanged either in the language in which it was filed in the Jurisdiction of the sending Competent Authority and/or in one of the official languages of the OECD. In all instances, a short summary of the Reportable Arrangement will be provided in one of the official languages of the OECD, unless two or more Competent Authorities agree on another arrangement with respect to the language to be used.
4. The Competent Authorities will agree on one or more methods for data transmission including encryption standards and will specify those in the notification pursuant to subparagraph 1(c) of Section 6.

### **SECTION 4**

#### **Confidentiality and Data Safeguards**

1. All information exchanged is subject to the confidentiality rules and other safeguards provided for in the Convention, including the provisions limiting the use of the information exchanged and, to the extent needed to ensure the necessary level of protection of personal data, in accordance with the safeguards which may be specified by the supplying Competent Authority as required under its domestic law in the notification pursuant to subparagraph 1(d) of Section 6.
2. A Competent Authority will notify the Co-ordinating Body Secretariat immediately regarding any breach of confidentiality or failure of safeguards and any sanctions and

remedial actions consequently imposed. The Co-ordinating Body Secretariat will notify all Competent Authorities with respect to which this is an Agreement in effect with the first mentioned Competent Authority.

## **SECTION 5**

### **Consultations and Amendments**

1. If any difficulties in the implementation or interpretation of this Agreement arise, a Competent Authority may request consultations with one or more Competent Authorities to develop appropriate measures to ensure that this Agreement is fulfilled. The Competent Authority that requested the consultations shall ensure, as appropriate, that the Co-ordinating Body Secretariat is notified of any measures that were developed and the Co-ordinating Body Secretariat will notify all Competent Authorities, even those that did not participate in the consultations, of any measures that were developed.
2. This Agreement may be amended by consensus by written agreement of all of the Competent Authorities that have the Agreement in effect. Unless otherwise agreed upon or specified by a Competent Authority in a notification to the Co-ordinating Body Secretariat, such an amendment is effective on the first day of the month following the expiration of a period of one month after the date of the last signature of such written agreement.

## **SECTION 6**

### **Term of Agreement**

1. A Competent Authority must provide, at the time of signature of this Agreement or as soon as possible after its Jurisdiction has the necessary laws in place to implement the Model Mandatory Disclosure Rules, a notification to the Co-ordinating Body Secretariat:
  - a) confirming that its Jurisdiction has Mandatory Disclosure Rules in place and specifying the effective date for the reporting of Reportable Arrangements under its Mandatory Disclosure Rules;
  - b) specifying whether the Jurisdiction is to be included in the list of non-reciprocal Jurisdictions;
  - c) specifying the methods for transmission and encryption of the information;
  - d) specifying safeguards, if any, for the protection of personal data;
  - e) confirming that it has in place adequate measures to ensure the required confidentiality and data safeguards standards are met; and
  - f) providing
    - (i) a list of the Jurisdictions of the Competent Authorities with respect to which it intends to have this Agreement in effect; or
    - (ii) a declaration by the Competent Authority that it intends to have this Agreement in effect with all other Competent Authorities that provide the required notifications under this paragraph 1.

Competent Authorities must notify the Co-ordinating Body Secretariat, promptly, of any subsequent change to be made to the above-mentioned notifications.

2. This Agreement will come into effect between two Competent Authorities on the date on which the second of the two Competent Authorities has provided all notifications to the Co-ordinating Body Secretariat under paragraph 1, including listing the other Competent Authority's Jurisdiction pursuant to subparagraph 1(f).
3. The Co-ordinating Body Secretariat will maintain a list that will be published on the OECD website of the Competent Authorities that have signed the Agreement and between which Competent Authorities this is an Agreement in effect.
4. The Co-ordinating Body Secretariat will publish on the OECD website the information provided by Competent Authorities pursuant to subparagraphs 1(a) and (b). The information provided pursuant to subparagraphs 1(c) through (f) will be made available to other signatories upon request in writing to the Co-ordinating Body Secretariat.
5. A Competent Authority may suspend the exchange of information under this Agreement by giving notice in writing to another Competent Authority that it has determined that there is or has been significant non-compliance by the second-mentioned Competent Authority with this Agreement. Such suspension will have immediate effect. For the purposes of this paragraph, significant non-compliance includes, but is not limited to, non-compliance with the confidentiality and data safeguard provisions of this Agreement and the Convention and/or a failure by the Competent Authority to provide timely or adequate information as required under this Agreement.
6. A Competent Authority may terminate its participation in this Agreement, or with respect to a particular Competent Authority, by giving notice of termination in writing to the Co-ordinating Body Secretariat. Such termination will become effective on the first day of the month following the expiration of a period of 12 months after the date of the notice of termination. In the event of termination, all information previously received under this Agreement will remain confidential and subject to the terms of the Convention.

## **SECTION 7**

### **Co-ordinating Body Secretariat**

Unless otherwise provided for in the Agreement, the Co-ordinating Body Secretariat will notify all Competent Authorities of any notifications that it has received under this Agreement and will provide a notice to all signatories of the Agreement when a new Competent Authority signs the Agreement.

Done in English and French, both texts being equally authentic.

## Part II – MDR XML Schema and User Guide

*Version 1.0 – March 2019*

### Introduction

The OECD model Mandatory Disclosure Rules (MDRs) that were approved in March 2018 are designed to provide tax administrations with information on CRS Avoidance Arrangements and Opaque Offshore Structures, including the users of those Arrangements and Structures and those involved with their supply. Information disclosed pursuant to the application of the MDR rules can be used both for compliance purposes and to inform future tax policy design. These rules should also have a deterrent effect against the design, marketing and use of arrangements covered by the rules.

The MDR rules require an Intermediary or user of a CRS Avoidance Arrangement or Opaque Offshore Structure to disclose certain information to its tax administration. Where such information relates to users that are resident in another jurisdiction it is contemplated that such information be exchanged with the tax administration(s) of that jurisdiction in accordance with relevant international legal instruments, such as the MDR Multilateral Competent Authority Agreement (MCAA). This is to provide tax administrations with information on schemes, their users and suppliers, for use in compliance activities, exchange with treaty partners and tax policy design. The MDR XML Schema and User Guide is designed to technically support these exchanges between Competent Authorities and to facilitate the use of the information by tax administrations by ensuring a standardised format.

### Key Elements

The information exchanged under the MDR rules and reflected in the MDR XML Schema has four key elements:

- A description of the arrangements that are required to be disclosed (i.e. the hallmarks of a disclosable MDR scheme);
- A description of the persons required to disclose such arrangements (i.e. the Intermediaries that are subject to reporting obligations under the MDR rules);
- A trigger for the imposition of a disclosure obligation (i.e. when an obligation to disclose crystallises under the rules and any exceptions from reporting); and
- The substantive information required to be reported.

The MDR XML Schema reflects these four key elements and has been designed for electronically holding and transmitting relevant MDR information. XML, ‘extensible markup language’, is commonly used for this purpose. Examples are the OECD’s Common Reporting Standard XML Schema, the OECD XML Schema for Country-by-Country Reporting and the United States’ FATCA XML Schema and the XML schemas for

exchanging information under the Council Directive 2011/16/EU of 15 February 2011 on administrative cooperation in the field of taxation.

This User Guide explains the information required to be included in each element to be reported in the MDR XML Schema. It also contains guidance on how to make corrections of data items within a file that can be processed automatically.

## How the MDR User Guide links to the MDR XML Schema

This User Guide is divided into logical sections based on the key elements of the schema and provides information on specific data elements and any attributes that describe that data element.

The MDR XML Schema information sections are:

- The Message Header with the sender, recipient(s), message type, language of the message and the timestamp;
- The MDR Body containing the substantive information to be reported that is divided in the following subsections:
  - **“Disclosing”** containing information on the identity and the relevant nexus of the disclosing person in relation to the CRS Avoidance Arrangement or Opaque Offshore Structure;
  - **MdrReport**, consisting of:
    - **“Reportable Taxpayer”** containing information on the identity of the Reportable Taxpayer in respect of the CRS Avoidance Arrangement or Opaque Offshore Structure;
    - **“Intermediaries”** setting out other Intermediaries that were involved in the promotion or implementation of the CRS Avoidance Arrangement or Opaque Offshore Structure; and
    - **“Structure”** containing details on the features and a structure chart of the disclosed CRS Avoidance Arrangement of Opaque Offshore Structure.

The requirement field for each data element and its attribute indicates whether the element is validation or optional in the MDR XML Schema.

**“Validation”** elements **MUST** be present for ALL data records in a file and an automated validation check can be undertaken. The sender should do a technical check of the data file content using XML tools to make sure all validation elements are present and, if they are not, a correction to the file should be made. The receiver may also check the presence of all validation elements and may reject the file in case such elements are missing.

Where there is a choice between 2 validation elements under a validation parent and only one is needed, this is shown as **“Validation (choice)”**.

Certain elements are labelled as **“Optional (Mandatory)”**, indicating that the element is in principle mandatory, unless the element must be left blank in the context of a correction of the other element (see the Corrections section for further detail) or indicating that the element is only required to be filled in certain cases. The User Guide further details these situations and the criteria to be used.

**“Optional”** elements are, while recommended, not required to be provided and may in certain instances represent a choice between one type or another, where one of them must be used (e.g. choice between address fix or address free).

Section 1.8 of the MDR User Guide contains further guidance on corrections.

**Appendix A** to the MDR User Guide shows a diagrammatic representation of the MDR XML Schema with all its elements. The numbers next to the headings are the corresponding section numbers in the User Guide text, which provides further guidance on the information to be provided in each element.

**Appendix B** to the MDR User Guide contains a Glossary of namespaces for the MDR XML Schema.



## MDR XML Schema Information

### Message Header

Information in the message header identifies the Competent Authority that is sending the message, as well as the Competent Authority receiving the message. It specifies when the message was created, the sender and receiver and the nature of the report (original, corrected, etc.).

Element	Attribute	Size	Input Type	Requirement
TransmittingCountry		2-character	iso:CountryCode_Type	Validation

The Transmitting Country element identifies the jurisdiction of the Competent Authority transmitting the message. It uses the 2-character alphabetic country code and country name list<sup>1</sup> based on the ISO 3166-1 Alpha 2 standard.

Element	Attribute	Size	Input Type	Requirement
ReceivingCountry			iso:CountryCode_Type	Validation

The Receiving Country element indicates the jurisdiction of the Competent Authority that is the intended recipient of the message. It uses the 2-character alphabetic country code based on the ISO 3166-1 Alpha 2 standard.

Element	Attribute	Size	Input Type	Requirement
MessageType			mdr:MessageType_EnumType	Validation

This data element specifies the type of message being sent. The only allowable entry in this field is “MDR”.

Element	Attribute	Size	Input Type	Requirement
Language		2-character	iso:LanguageCode_Type	Optional (Mandatory)

This data element specifies the language in which the content of the MDR report is being provided, by indicating the relevant language code pursuant to ISO 639 – Part 1 (ISO 639-1:2002). Where it is not possible to submit certain elements within the MDR report (e.g. an address or a name of an Intermediary) in the languages indicated above, the language in which these specific elements are provided may be indicated as an attribute to each of these elements.

Element	Attribute	Size	Input Type	Requirement
Warning		1 to 4'000 characters	mdr:StringMin1Max4000_Type	Optional

<sup>1</sup> The following disclaimer refers to all uses of the ISO country code list in the MDR XML Schema: “For practical reasons, the list is based on the ISO 3166-1 country list. The use of this list does not imply the expression by the OECD of any opinion whatsoever concerning the legal status of the territories listed. Its content is without prejudice to the status of or sovereignty over any territory, to the delimitation of international frontiers and boundaries and to the name of any territory, city or area.”

This data element is a free text field allowing input of specific cautionary instructions about use of the MDR report.

Element	Attribute	Size	Input Type	Requirement
Contact		1 to 4'000 characters	mdr:StringMin1Max4000_Type	Optional

This data element is a free text field allowing input of specific contact information for the sender of the message (i.e. the sending Competent Authority).

Element	Attribute	Size	Input Type	Requirement
MessageRefID		1 to 170 characters	mdr:StringMin1Max170_Type	Validation

This data element is a free text field capturing the sender's unique identifying number (created by the sender) that identifies the particular message being sent. The identifier allows both the sender and receiver to identify the specific message later if questions or corrections arise.

Element	Attribute	Size	Input Type	Requirement
MessageTypeIndic			mdr:MdrMessageTypeIndic_EnumType	Validation

This data element allows the sender to define the type of message sent. This element must be aligned with the record DocTypeIndic which also identifies whether data is new or corrected/deleted (see Guidance on the Correction Process below). Messages must contain all new or all corrected/deleted data, but not a combination of both.

The possible values are:

- MDR401 – The message contains new information (only records with a DocTypeIndic of OECD1 and/or OECD0)
- MDR402 – The message contains corrections/deletions for previously sent information (only records with a DocTypeIndic of OECD2, OECD3 and/or OECD0)

Element	Attribute	Size	Input Type	Requirement
Timestamp			xsd:dateTime	Validation

This data element identifies the date and time when the message was compiled. It is anticipated this element will be automatically populated by the host system. The format for use is YYYY-MM-DD'T'hh:mm:ss.nnn. Fractions of seconds may be used (in such a case the milliseconds will be provided on 3 digits, see “.nnn” in the format above). *Example:* 2018-09-15T14:37:40 or 2018-09-15T14:37:40.789 (with milliseconds).

## PersonParty\_Type

The data elements in this section are used to provide identification information on individuals that are either the person disclosing the MDR arrangement, the Reportable Taxpayer and/or an Intermediary. This complex type is comprised of the following data elements:

Element	Attribute	Size	Input Type	Requirement
ResCountryCode		2-character	iso:CountryCode_Type	Validation

Element	Attribute	Size	Input Type	Requirement
TIN			mdr:TIN_Type	Validation

Element	Attribute	Size	Input Type	Requirement
Name			mdr:NamePerson_Type	Validation

Element	Attribute	Size	Input Type	Requirement
Address			mdr:Address_Type	Validation

Element	Attribute	Size	Input Type	Requirement
BirthDate			xsd:date	(Optional) Mandatory

### *ResCountryCode*

Element	Attribute	Size	Input Type	Requirement
ResCountryCode		2-character	iso:CountryCode_Type	Validation

This repeatable data element describes the tax residence country code(s)<sup>2</sup> of the individual Intermediary or Reportable Taxpayer and must be present in all data records.

The complete information including all residence country codes that have been identified as applicable to the Reportable Taxpayer may be sent to every Competent Authority of a jurisdiction of residence. It is recommended that the Competent Authority sends a data record to each of the residence jurisdictions showing all reportable residence jurisdictions.

### *TIN (TIN\_Type)*

Element	Attribute	Size	Input Type	Requirement
TIN		1 to 200 characters	mdr:TIN_Type	Validation

This data element provides the tax identification number (TIN) used by the tax administration of the jurisdiction of residence of the Reportable Taxpayer or Intermediary. In case the Intermediary or Reportable Taxpayer does not have a TIN, or the TIN is not known to the sending Competent Authority, the value “NOTIN” should be entered.

Element	Attribute	Size	Input Type	Requirement
TIN	issuedBy	2-character	iso:CountryCode_Type	Optional (Mandatory)

This attribute describes the jurisdiction that issued the TIN. It should be always provided, unless NOTIN is entered in the TIN element.

### *NamePerson\_Type*

Element	Attribute	Size	Input Type	Requirement
Name			mdr:NamePerson_Type	Validation

Element	Attribute	Size	Input Type	Requirement
NamePerson_Type	nameType		stf:OECDNameType_EnumType	Optional

<sup>2</sup> For practical reasons, the ResCountryCode list is based on the ISO 3166-1 country list. The use of this list does not imply the expression by the OECD of any opinion whatsoever concerning the legal status of the territories listed. Its content is without prejudice to the status of or sovereignty over any territory, to the delimitation of international frontiers and boundaries and to the name of any territory, city or area.

This data element allows the reporting of both the name at birth and the name after marriage.

### OECDNameType\_EnumType

It is possible for MDR records to contain several names for the same person. This is a qualifier to indicate the type of a particular name. Such types include nicknames ('nick'), names under which a party does business ('dba' a short name for the entity, or a name that is used for public acquaintance instead of the official business name) etc.

The possible values are:

- OECD202=indiv
- OECD203=alias
- OECD204=nick
- OECD205=aka
- OECD206=dba
- OECD207=legal
- OECD208=atbirth

Element	Attribute	Size	Input Type	Requirement
NamePerson_Type	language	2-character	iso:LanguageCode_Type	Optional

In this attribute to the NamePerson Type element, the language in which the name is entered can be specified, in case the language used differs from the language entered in the Language element in the Message Header.

Element	Attribute	Size	Input Type	Requirement
PrecedingTitle		1 to 200 characters	mdr:StringMin1Max200_Type	Optional

Element	Attribute	Size	Input Type	Requirement
Title		1 to 200 characters	mdr:StringMin1Max200_Type	Optional

Element	Attribute	Size	Input Type	Requirement
FirstName		1 to 200 characters	mdr:StringMin1Max200_Type	Validation

This data element is required for MDR reports. If the sending Competent Authority was not provided with a complete first name for a Reportable Taxpayer or Intermediary an initial or NFN (“No First Name”) may be used here.

Element	Attribute	Size	Input Type	Requirement
FirstName	xnlNameType	1 to 200 characters	mdr:StringMin1Max200_Type	Optional

Element	Attribute	Size	Input Type	Requirement
MiddleName		1 to 200 characters	mdr:StringMin1Max200_Type	Optional

This data element allows for the Individual’s Middle Name. The data is optional.

Element	Attribute	Size	Input Type	Requirement
MiddleName	xnlNameType	1 to 200 characters	mdr:StringMin1Max200_Type	Optional

Element	Attribute	Size	Input Type	Requirement
NamePrefix		1 to 200 characters	mdr:StringMin1Max200_Type	Optional

Element	Attribute	Size	Input Type	Requirement
NamePrefix	xnlNameType	1 to 200 characters	mdr:StringMin1Max200_Type	Optional

Element	Attribute	Size	Input Type	Requirement
LastName		1 to 200 characters	mdr:StringMin1Max200_Type	Validation

This data element is required for MDR reports. This field can include any prefix or suffix legally used by the Reportable Taxpayer or Intermediary.

As the element is a string it is possible to use this for a free format name or two last names although wherever possible the structured first name and last name should be used.

Element	Attribute	Size	Input Type	Requirement
LastName	xnlNameType	1 to 200 characters	mdr:StringMin1Max200_Type	Optional

Element	Attribute	Size	Input Type	Requirement
GenerationIdentifier		1 to 200 characters	mdr:StringMin1Max200_Type	Optional

Element	Attribute	Size	Input Type	Requirement
Suffix		1 to 200 characters	mdr:StringMin1Max200_Type	Optional

Element	Attribute	Size	Input Type	Requirement
GeneralSuffix		1 to 200 characters	mdr:StringMin1Max200_Type	Optional

### *Address\_Type*

There are two alternative options for Address type in the MDR XML schema – AddressFix and AddressFree. In principle, AddressFix should be used in all cases.

Element	Attribute	Size	Input Type	Requirement
CountryCode		2-character	iso:CountryCode_Type	Validation

This data element provides the country code associated with the relevant Reportable Taxpayer or Intermediary.

Element	Attribute	Size	Input Type	Requirement
AddressFree		1 to 4000 characters	mdr:StringMin1Max4000_Type	Optional

This data element allows input of address information in free text. If the sending Competent Authority chooses to enter the data in 'AddressFree', all available address details shall be presented as one string of bytes, with blanks, slashes or carriage returns being used as a delimiter between parts of the address. This option should only be used if the data cannot be presented in the AddressFix format.

NOTE: If the sending Competent Authority selects AddressFix, it will have the option of inputting the full street address in the AddressFree element rather than using the related fixed elements. In this case, the city, subentity, and postal code information should still be entered in the appropriate fixed elements.

Element	Attribute	Size	Input Type	Requirement
AddressType	legalAddressType		stf:OECDLegalAddressType_EnumType	Optional

### OECDLegalAddressType\_EnumType

This is a datatype for an attribute to an address. It serves to indicate the legal character of that address (residential, business, etc.). In the context of corporate Reportable Taxpayers or Intermediaries, generally OECD 303 or OECD304 should be used. The possible values are:

- OECD301=residentialOrBusiness
- OECD302=residential
- OECD303=business
- OECD304=registeredOffice
- OECD305=unspecified

Element	Attribute	Size	Input Type	Requirement
AddressType	language	2-character	iso:LanguageCode_Type	Optional

In this attribute to the Address Type element, the language in which the address is entered can be specified, in case the language used differs from the language entered in the Language element in the Message Header.

Element	Attribute	Size	Input Type	Requirement
Street		1 to 200 characters	mdr:StringMin1Max200_Type	Optional (Mandatory)

Element	Attribute	Size	Input Type	Requirement
BuildingIdentifier		1 to 200 characters	mdr:StringMin1Max200_Type	Optional

Element	Attribute	Size	Input Type	Requirement
SuiteIdentifier		1 to 200 characters	mdr:StringMin1Max200_Type	Optional

Element	Attribute	Size	Input Type	Requirement
FloorIdentifier		1 to 200 characters	mdr:StringMin1Max200_Type	Optional

Element	Attribute	Size	Input Type	Requirement
DistrictName		1 to 200 characters	mdr:StringMin1Max200_Type	Optional

Element	Attribute	Size	Input Type	Requirement
POB		1 to 200 characters	mdr:StringMin1Max200_Type	Optional

Element	Attribute	Size	Input Type	Requirement
PostCode		1 to 200 characters	mdr:StringMin1Max200_Type	Optional (Mandatory)

Element	Attribute	Size	Input Type	Requirement
City		1 to 200 characters	mdr:StringMin1Max200_Type	Validation

Element	Attribute	Size	Input Type	Requirement
CountrySubentity		1 to 200 characters	mdr:StringMin1Max200_Type	Optional

The above data elements comprise the AddressFix type.

### *Birth date*

Element	Attribute	Size	Input Type	Requirement
BirthDate			xsd:date	(Optional) Mandatory

This data element identifies the date of birth of an individual Reportable Taxpayer or Intermediary. The date of birth may be left empty when it is not reported to the sending Competent Authority under its domestic MDR rules.

The data format is: YYYY-MM-DD.

## OrganisationParty\_Type

This complex type is used to identify non-individual Reportable Taxpayers and Intermediaries (e.g. corporates, trusts, partnerships etc.). It comprises the following data elements:

Element	Attribute	Size	Input Type	Requirement
ResCountryCode		2-character	iso:CountryCode_Type	Validation

Element	Attribute	Size	Input Type	Requirement
TIN		1 to 200 characters	mdr:TIN_Type	Validation

Element	Attribute	Size	Input Type	Requirement
IN		1 to 200 characters	mdr:OrganisationIN_Type	Optional

Element	Attribute	Size	Input Type	Requirement
Name		1 to 200 characters	mdr:NameOrganisation_Type	Validation

Element	Attribute	Size	Input Type	Requirement
Address			mdr:Address_Type	Validation

### *ResCountryCode*

Element	Attribute	Size	Input Type	Requirement
ResCountryCode		2-character	iso:CountryCode_Type	Validation

This data element should contain the tax residence country code(s) of the tax jurisdiction of a Reportable Taxpayer or Intermediary (or, in case of a permanent establishment that is

a Reportable Taxpayer or Intermediary, the jurisdiction in which such permanent establishment is subject to tax).

### *TIN (TIN\_Type)*

Element	Attribute	Size	Input Type	Requirement
TIN		1 to 200 characters	mdr:TIN_Type	Validation

This data element provides the tax identification number (TIN) used by the tax administration of the jurisdiction of residence of the Reportable Taxpayer or Intermediary. In case the Intermediary or Reportable Taxpayer does not have a TIN, or the TIN is not known to the sending Competent Authority, the value “NOTIN” should be entered.

Element	Attribute	Size	Input Type	Requirement
TIN	issuedBy	2-character	iso:CountryCode_Type	Optional (Mandatory)

This attribute describes the jurisdiction that issued the TIN. It should be always provided, unless NOTIN is entered in the TIN element.

### *Entity IN (OrganisationIN\_Type)*

Element	Attribute	Size	Input Type	Requirement
IN		1 to 200 characters	mdr:OrganisationIN_Type	Optional

This data element can be provided (and repeated) if there are other INs available, such as a company registration number or an Entity Identification Number (EIN).

Element	Attribute	Size	Input Type	Requirement
IN	issuedBy	2-character	iso:CountryCode_Type	Optional

This attribute describes the jurisdiction that issued the IN. If the issuing jurisdiction is not known or the IN is not issued by a jurisdiction, then this element may be left blank. In such case, the body issuing the IN should be indicated in the Warning element.

Element	Attribute	Size	Input Type	Requirement
IN	INType	1 to 200 characters	mdr:StringMin1Max200_Type	Optional

This attribute defines the type of IN being sent (e.g. EIN, LEI).

### *Organisation Name*

Element	Attribute	Size	Input Type	Requirement
Name		1 to 200 characters	mdr:NameOrganisation_Type	Validation

This element should contain the full legal name of the Reportable Taxpayer or Intermediary, including the domestic designation for the legal form, as indicated in its articles of incorporation or any similar document.

Element	Attribute	Size	Input Type	Requirement
Name	language	2-character	iso:LanguageCode_Type	Optional

In this attribute to the Name element, the language in which the name is entered can be specified, in case the language used differs from the language entered in the Language element in the Message Header.



## Person or Organisation Type

In all instances where identification information is required to be provided with respect to a Reportable Taxpayer or Intermediary in the MDR report, a choice between Individual and Organisation is to be made in order to determine the detailed information to be entered, as set out in the preceding sections.

Element	Attribute	Size	Input Type	Requirement
Individual			mdr:PersonParty_Type	Validation (Choice)

Element	Attribute	Size	Input Type	Requirement
Organisation			mdr:OrganisationParty_Type	Validation (Choice)

## MDR Body

The MDR Body contains the information on the identity and nexus of the disclosing person with respect to the CRS Avoidance Arrangement or Opaque Offshore Structure, the information on the identity of the Reportable Taxpayer, the information on the identity and role of any other Intermediaries, as well as information on the structure and features of the disclosed CRS Avoidance Arrangement or Opaque Offshore Structure.

Element	Attribute	Size	Input Type	Requirement
MdrBody			mdr:MdrBody_Type	Validation

As set out above, the MDR Body element is composed of the following elements:

Element	Attribute	Size	Input Type	Requirement
Disclosing			mdr:CorrectableDisclosing_Type	Validation

This element contains identification information on the disclosing person, as well as its nexus with the CRS Avoidance Arrangement or Opaque Offshore Structure.

Element	Attribute	Size	Input Type	Requirement
MdrReport			mdr:CorrectableMdrReport_Type	Optional (Mandatory)

This element contains the information on the identity of the Reportable Taxpayer(s), other Intermediaries, as well as the structure of the disclosed CRS Avoidance Arrangement or Opaque Offshore Structure.

### Disclosing

Element	Attribute	Size	Input Type	Requirement
Disclosing			mdr:CorrectableDisclosing_Type	Validation

This element contains identification information on the disclosing person, as well as its nexus with the CRS Avoidance Arrangement or Opaque Offshore Structure. It is composed of:

Element	Attribute	Size	Input Type	Requirement
ID			mdr:PersonOrOrganisation_Type	Validation

This element contains the identification information on the person disclosing the CRS Avoidance Arrangement or Opaque Offshore Structure, in accordance with the Individual or Organisation Party types set out above.

Element	Attribute	Size	Input Type	Requirement
Capacity			mdr:CapacityDisclosingPerson_EnumType	Validation

This repeatable element clarifies in with capacity the person is disclosing the CRS Avoidance Arrangement or Opaque Offshore Structure. The allowed alternative entries are:

- MDR501 – Intermediary – Promoter
- MDR502 – Intermediary – Service Provider
- MDR503 – Intermediary – Client
- MDR504 – Reportable Taxpayer

Element	Attribute	Size	Input Type	Requirement
Nexus			mdr:NexusDisclosure_EnumType	Validation

This repeatable element clarifies the nexus of the disclosing person to the jurisdiction in which the disclosure of the CRS Avoidance Arrangement or Opaque Offshore Structure has been made. The allowable entries are one or more of the following, depending on the one or more nexuses that a disclosing person has to the jurisdiction in which the disclosure is made:

- MDR601 – Tax residence
- MDR602 – Incorporation/Establishment
- MDR603 – Place of Management
- MDR604 – Branch

Element	Attribute	Size	Input Type	Requirement
DocSpec			mdr:DocSpec_Type	Validation

DocSpec identifies the particular record within the MDR message being transmitted. It permits the identification of record requiring correction (for further guidance see the Corrections section in this User Guide).

### *MdrReport*

Element	Attribute	Size	Input Type	Requirement
MdrReport			mdr:CorrectableMdrReport_Type	Optional (Mandatory)

The MdrReport element is composed of:

Element	Attribute	Size	Input Type	Requirement
ReportableTaxPayer			mdr:TaxPayer_Type	Validation

This repeatable element contains information on the identity of the one or more Reportable Taxpayers with respect to the disclosed CRS Avoidance Arrangement or Opaque Offshore Structure.

Element	Attribute	Size	Input Type	Requirement
Intermediaries			mdr:Intermediary_Type	Optional (Mandatory)

This repeatable element contains information on the identity and roles of any other Intermediaries with respect to the disclosed CRS Avoidance Arrangement or Opaque Offshore Structure.

Element	Attribute	Size	Input Type	Requirement
Structure			mdr:Structure_Type	Validation

This element contains detailed information on the structure and features of the disclosed CRS Avoidance Arrangement or Opaque Offshore Structure.

Element	Attribute	Size	Input Type	Requirement
DocSpec			mdr:DocSpec_Type	Validation

DocSpec identifies the particular record within the MDR message being transmitted. It permits the identification of record requiring correction (for further guidance see the Corrections section).

### *Reportable Tax Payer*

Element	Attribute	Size	Input Type	Requirement
ReportableTaxPayer			mdr:TaxPayer_Type	Validation

This repeatable element contains information on the identity of the one or more Reportable Taxpayers with respect to the disclosed CRS Avoidance Arrangement or Opaque Offshore Structure. This element is also to be provided in case the same Reportable Taxpayer has already been identified as the disclosing person in the Disclosing element.

The element is composed of:

Element	Attribute	Size	Input Type	Requirement
ID			mdr:PersonOrOrganisation_Type	Validation

This element contains the identification information on the Reportable Taxpayer with respect to the CRS Avoidance Arrangement or Opaque Offshore Structure, in accordance with the Individual or Organisation Party types set out above.

### *Intermediaries*

Element	Attribute	Size	Input Type	Requirement
Intermediaries			mdr:Intermediary_Type	Optional (Mandatory)

This repeatable element contains information on the identity and roles of any other Intermediaries (i.e. other than an Intermediary that is the disclosing person and has been identified as such in the Disclosing element) with respect to the disclosed CRS Avoidance Arrangement or Opaque Offshore Structure.

The element is composed of:

Element	Attribute	Size	Input Type	Requirement
ID			mdr:PersonOrOrganisation_Type	Validation

This element contains the identification information on an Intermediary with respect to the CRS Avoidance Arrangement or Opaque Offshore Structure, in accordance with the Individual or Organisation Party types set out above.

Element	Attribute	Size	Input Type	Requirement
Role			mdr:IntermediaryRole_EnumType	Validation

This repeatable element indicates the role of the Intermediary with respect to the CRS Avoidance Arrangement or Opaque Offshore Structure. In line with the MDR rules, this role can be that of a Promoter and/or a Service Provider and/or a Client. As such, the allowed entries are:

- MDR1101 – Promoter
- MDR1102 – Service Provider
- MDR1103 – Client

### Structure

Element	Attribute	Size	Input Type	Requirement
Structure			mdr:Structure_Type	Validation

This element contains detailed information on the structure and features of the disclosed CRS Avoidance Arrangement or Opaque Offshore Structure.

This element is composed of:

Element	Attribute	Size	Input Type	Requirement
Arrangement				Validation

The Arrangement element indicates whether the disclosed arrangement is a CRS Avoidance Arrangement or an Opaque Offshore Structure (OOS). As such, this element allows for a choice between “CRS Avoidance” and “OOS”.

Element	Attribute	Size	Input Type	Requirement
CrsAvoidance			mdr:CrsAvoidanceArrangement_Type	Validation (Choice)

Element	Attribute	Size	Input Type	Requirement
OOS			mdr:OpaqueOffshoreStructure_Type	Validation (Choice)

### CRS Avoidance Arrangement

Element	Attribute	Size	Input Type	Requirement
CrsAvoidance			mdr:CrsAvoidanceArrangement_Type	Validation (Choice)

The CRS Avoidance element is composed of:

Element	Attribute	Size	Input Type	Requirement
DisclosureDate			xsd:date	Validation

This element specifies the date on which the disclosure of the CRS Avoidance Arrangement was made.

Element	Attribute	Size	Input Type	Requirement
Reason			mdr:DisclosureReasonCRSAA_EnumType	Optional (Mandatory)

This element clarifies, in accordance with the MDR rules, what event triggered the disclosure obligation for an Intermediary. The allowed entries are:

- MDR701 – Arrangement available for implementation
- MDR702 – Provision of Relevant Services

This element is not to be completed when a Reportable Taxpayer has made the disclosure.

Element	Attribute	Size	Input Type	Requirement
Type			mdr:CRSAvoidanceArrangement_EnumType	Validation

This repeatable element clarifies the type of CRS Avoidance Arrangement that is being disclosed, in line with the categories foreseen in the MDR rules with respect to the definitional scope of a CRS Avoidance Arrangement. Accordingly, the allowed entries are:

- MDR801 – Not a Financial Account
- MDR802 – Conversion or transfer
- MDR803 – Incorrect due diligence
- MDR804 – Non-reporting of Controlling Persons
- MDR805 – Disguise of payments
- MDR806 – Other

Element	Attribute	Size	Input Type	Requirement
OtherInfo		1 to 4'000 characters	mdr:StringMin1Max4000WithLang_Type	Optional

This repeatable element allows the specification of reasons other than those contemplated by MDR801 through MDR805 that have led to the conclusion that the arrangement is a CRS Avoidance Arrangement subject to disclosure, i.e. when MDR806 was selected. This is expected to be the case both when the arrangement does not clearly fall within the scope of one of the cases reflected by MDR801 through MDR805 or when the arrangement covers more than one of the cases foreseen by MDR801 through MDR805.

The element is repeatable to allow all necessary information with respect to the reasons for concluding that the arrangement is a CRS Avoidance Arrangement to be provided in a free text format, without having a single element having more than 4000 characters.

Element	Attribute	Size	Input Type	Requirement
OtherInfo	language	2-character	iso:LanguageCode_Type	Optional

In this attribute to the Other Info element, the language in which the information is entered can be specified, to the extent this language is different from the language indicated in the Message Header.

Element	Attribute	Size	Input Type	Requirement
StructureChart			mdr:ReportableTaxPayerChart_Type	Optional

This element allows the CRS Avoidance Arrangement to be depicted as a (logical) structure, in addition to the narrative description of the arrangement. This guidance to depict the structure is provided below.

Element	Attribute	Size	Input Type	Requirement
Narrative		1 to 4'000 characters	mdr:StringMin1Max4000WithLang_Type	Validation

The Narrative element permits the narrative description of the CRS Avoidance Arrangement, including a description of the features of the arrangement that are designed to have, marketed as having, or have the effect of, circumventing CRS Legislation in a free text format.

The element is repeatable to allow all necessary information to be provided in a free text format, without having a single element having more than 4000 characters.

Element	Attribute	Size	Input Type	Requirement
Narrative	language	2-character	iso:LanguageCode_Type	Optional

In this attribute to the Narrative element, the language in which the information is entered can be specified, to the extent this language is different from the language indicated in the Message Header.

Element	Attribute	Size	Input Type	Requirement
Jurisdictions			iso:CountryCode_Type	Validation

This repeatable element allows the specification of the jurisdictions in which the CRS Avoidance Arrangement has been made available for implementation.

Element	Attribute	Size	Input Type	Requirement
Summary		1 to 4'000 characters	mdr:StringMin1Max4000WithLang_Type	Validation

The Summary element contains a short summary of the key features of the CRS Avoidance Arrangement, i.e. a factual description of those features of the Arrangement that are designed to have, marketed as having, or have the effect of, circumventing the CRS Legislation in up to 4000 characters. This is to give the sending Competent Authority a first orientation and an addition to the more elaborate information in the Narrative element.

The Summary element should not be repeated, except for transliteration purposes, in case the information is provided in more than one language.

Element	Attribute	Size	Input Type	Requirement
Summary	language	2-character	iso:LanguageCode_Type	Optional

In this attribute to the Summary element, the language in which the information is entered can be specified, to the extent this language is different from the language indicated in the Message Header.

### Opaque Offshore Structure

Element	Attribute	Size	Input Type	Requirement
OOS			mdr:OpaqueOffshoreStructure_Type	Validation (Choice)

The OOS element is composed of:

Element	Attribute	Size	Input Type	Requirement
DisclosureDate			xsd:date	Validation

This element specifies the date on which the disclosure of the Opaque Offshore Structure was made.

Element	Attribute	Size	Input Type	Requirement
Reason			mdr:DisclosureReasonOOS_EnumType	Optional (Mandatory)

This element clarifies, in accordance with the MDR rules, what event triggered the disclosure obligation for an Intermediary. The allowed entries are:

- MDR901 – Arrangement available for implementation
- MDR902 – Provision of Relevant Services

This element is not to be completed when a Reportable Taxpayer has made the disclosure.

Element	Attribute	Size	Input Type	Requirement
Type			mdr:OOS_EnumType	Validation

This repeatable element clarifies the type of Opaque Offshore Structure that is being disclosed, in line with the categories foreseen in the MDR rules with respect to the definitional scope of an Opaque Offshore Structure. Accordingly, the allowed entries are:

- MDR1001 – Use of nominees
- MDR1002 – Means of indirect control
- MDR1003 – Access to assets without disclosure of Beneficial Owners
- MDR1004 – Use of Legal Persons without basic corporate information
- MDR1005 – Use of Legal Persons without obligation to disclose shareholders
- MDR1006 – Use of Legal Persons without notification of change of shareholders/partners
- MDR1007 – Use of Legal Arrangements without Beneficial Ownership information
- MDR1008 – Other

Element	Attribute	Size	Input Type	Requirement
OtherInfo		1 to 4'000 characters	mdr:StringMin1Max4000WithLang_Type	Optional

This repeatable element allows the specification of reasons other than those contemplated by MDR1001 through MDR1007 that have led to the conclusion that the arrangement is an Opaque Offshore Structure subject to disclosure, i.e. when MDR1008 was selected. This is expected to be the case both when the arrangement does not clearly fall within the scope of one of the cases reflected by MDR1001 through MDR1007 or when the arrangement covers more than one of the cases foreseen by MDR1001 through MDR1007.

The element is repeatable to allow all necessary information with respect to the reasons for concluding that the arrangement is an Opaque Offshore Structure be provided in a free text format, without having a single element having more than 4000 characters.

Element	Attribute	Size	Input Type	Requirement
OtherInfo	language	2-character	iso:LanguageCode_Type	Optional

In this attribute to the Other Info element, the language in which the information is entered can be specified, to the extent this language is different from the language indicated in the Message Header.

Element	Attribute	Size	Input Type	Requirement
StructureChart			mdr:ReportableTaxPayerChart_Type	Optional

This element allows the Opaque Offshore Structure to be depicted as a (logical) structure, in addition to the narrative description of the arrangement. This guidance to depict the structure is provided below.

Element	Attribute	Size	Input Type	Requirement
Narrative		1 to 4'000 characters	mdr:StringMin1Max4000WithLang_Type	Validation

The Narrative element permits the narrative description of the Opaque Offshore Structure, including a description of the features that have the effect or not allowing the accurate determination of the Reportable Taxpayer's Beneficial Ownership or creating the appearance that the Reportable Taxpayer is not a Beneficial Owner of the Passive Offshore Vehicle, in a free text format.

The element is repeatable to allow all necessary information to be provided in a free text format, without having a single element having more than 4000 characters.

Element	Attribute	Size	Input Type	Requirement
Narrative	language	2-character	iso:LanguageCode_Type	Optional

In this attribute to the Narrative element, the language in which the information is entered can be specified, to the extent this language is different from the language indicated in the Message Header.

Element	Attribute	Size	Input Type	Requirement
Jurisdictions			iso:CountryCode_Type	Validation

This repeatable element allows the specification of the jurisdictions in which the Opaque Offshore Structure has been made available for implementation.

Element	Attribute	Size	Input Type	Requirement
Summary		1 to 4'000 characters	mdr:StringMin1Max4000WithLang_Type	Validation

The Summary element provides an opportunity to include a short summary of the key features of the Opaque Offshore Structure, i.e. a factual description of those features that have the effect of not allowing the accurate determination of the Reportable Taxpayer's Beneficial Ownership or creating the appearance that the Reportable Taxpayer is not a Beneficial Owner of the Passive Offshore Vehicle in up to 4000 characters. This is to give the sending Competent Authority a first orientation and an addition to the more elaborate information in the Narrative element.

The Summary element should not be repeated, except for transliteration purposes, in case the information is provided in more than one language.

Element	Attribute	Size	Input Type	Requirement
Summary	language	2-character	iso:LanguageCode_Type	Optional

In this attribute to the Summary element, the language in which the information is entered can be specified, to the extent this language is different from the language indicated in the Message Header.

#### Structure Chart (ReportableTaxPayerChart\_Type)

Element	Attribute	Size	Input Type	Requirement
StructureChart			mdr:ReportableTaxPayerChart_Type	Optional

This element allows the CRS Avoidance Arrangement or Opaque Offshore Structure to be depicted as a (logical) structure, in addition to the narrative description of the arrangement, where the disclosing person considers this helpful for the undertaking of the arrangement. It allows the depiction of each entity or individual involved in the arrangement, including its ownership and the amounts invested with respect to that entity or individual for the arrangement. It also allows to further describe the role, capital and cash flow at each level of the structure.

For the purpose of entering the structure chart information, the starting point is the Reportable Taxpayer, and its investments and/or ownership in other persons, as the top of the structure chart. The structure chart can then be extended to subsidiary levels, as required, by repeating the Structure Chart element as so-called "Children". An example in this respect is provided at the Child RTP element description below.

The Structure Chart element is thus composed of:



Element	Attribute	Size	Input Type	Requirement
ID			mdr:PersonOrOrganisation_Type	Validation

This element contains the identification information on each entity or individual that is relevant to describe the structure of the CRS Avoidance Arrangement or Opaque Offshore Structure, in accordance with the Individual or Organisation Party types set out above.

Element	Attribute	Size	Input Type	Requirement
Ownership			mdr:Percentage_Type	Optional

This element allows the specification of the ownership in the entity in percentages, by indicating a number between 0 and 100. It is not to be provided for the top level Structure Chart element.

Element	Attribute	Size	Input Type	Requirement
InvestAmount			mdr:MonAmnt_Type	Optional

This element allows the specification of the investment amount in the entity in full units, i.e. without decimals. It is not to be provided for the top-level Structure Chart element.

Element	Attribute	Size	Input Type	Requirement
InvestAmount	currCode	3 characters	iso:currCode_Type	Validation

This element specifies the currency of the investment amount. All amounts must be accompanied by the appropriate 3-character currency code based on the ISO 4217 Alpha 3 Standard<sup>3</sup>.

Element	Attribute	Size	Input Type	Requirement
OtherInfo		1 to 4'000 characters	mdr:StringMin1Max4000WithLang_Type	Optional

This element allows specifying, for each entity or individual in the Structure Chart, any relevant information with respect to the role of the entity or individual, as well as the link with the next level entity or individual. Such information could for instance include details on the contractual or legal arrangements, the capital invested, the annual cash flows and the nature of the link between two levels (e.g. shareholder, beneficiary of trustee, agent etc.). It is a repeatable element in a free text format of 4000 characters each.

Element	Attribute	Size	Input Type	Requirement
OtherInfo	language	2-character	iso:LanguageCode_Type	Optional

In this attribute to the Other Info element, the language in which the information is entered can be specified, to the extent this language is different from the language indicated in the Message Header.

Element	Attribute	Size	Input Type	Requirement
ListChilds				Optional

This element allows the creation of the next level of subsidiary elements or entity or individual in the structure chart (e.g. to depict an entity wholly owned by the Reportable Taxpayer). It is to be provided only if this a previously entered Reportable Tax Payer Chart has children. The example below the ChildRTP elements clarifies its practical use.

<sup>3</sup> The following disclaimer refers to all uses of the ISO currency code list in the MDR schema: “For practical reasons, the list is based on the ISO 4217 Alpha 3. The use of this list does not imply the expression by the OECD of any opinion whatsoever concerning the legal status of the territories listed. Its content is without prejudice to the status of or sovereignty over any territory, to the delimitation of international frontiers and boundaries and to the name of any territory, city or area.”

Element	Attribute	Size	Input Type	Requirement
ChildRTP			mdr:ReportableTaxPayerChart_Type	Validation

This element contains the information on a child entity or individual in accordance with the Structure Chart element set out in this section.

#### Guidance and Example:

The type ReportableTaxPayerChart\_Type is a hierarchical type, the element ListChilds will allow to list the children in the Structure Chart. The element ChildRTP is using the same type (ReportableTaxPayerChart\_Type) as its parent element StructureChart (which is also of the same type ReportableTaxPayerChart\_Type), thus creating a hierarchical type. This is to provide an organisational chart (a structure of Reportable Tax Payer).

*For example:*

Top Parent – Level 1

List childs:

- Child 2.1

Ownership 50%

List childs: N/A

- Child 2.2

Ownership 50%

List childs:

- Child 3.1

Ownership 75%

List childs: N/A

- Child 3.2

Ownership 25%

List childs: N/A

## Schema version

The version of the schema and the corresponding business rules have a unique version number assigned that usually consists of two numbers separated by a period sign: major and minor version (ex: 1.0). The version number could also contain a third number (ex: 1.0.1) which indicates that the schema was revised with very limited changes (ex: only new enumerations were added).

The version is identified by the version attribute on the schema element. The target namespace of the MDR schema contains only the major version.

```
<xsd:schema xmlns:mdr="urn:oecd.ties.mdr.v1" xmlns:xsd="http://www.w3.org/2001/XMLSchema" xmlns:stf="urn:oecd.ties.mdrstf.v1" xmlns:iso="urn:oecd.ties.isomdrtypes.v1" targetNamespace="urn:oecd.ties.mdr.v1" elementFormDefault="qualified" attributeFormDefault="unqualified" version="1.0">
  <xsd:import namespace="urn:oecd.ties.isomdrtypes.v1" schemaLocation="IsoMdrTypes_v1.0.xsd"/>
  <xsd:import namespace="urn:oecd.ties.mdrstf.v1" schemaLocation="OecdMdrTypes_v1.0.xsd"/>
```

Element	Attribute	Size	Input Type	Requirement
MDR_OECD	version	1 to 10 characters	mdr:StringMin1Max10_Type	(Optional) Mandatory

The root element MDR\_OECD version attribute in the XML report file must be set to the value of the schema version. This will identify the schema version that was used to create the report.

For the MDR schema version 1.0, the version attribute must be set to the value “1.0”.

## Transliteration

As reflected in the MDR XML Schema, the sending jurisdiction may send designatory data (e.g. name or address) and certain narrative information (e.g. with respect to the features of a CRS Avoidance Arrangement or Opaque Offshore Structure) in both domestic alphabet or literation and separately in Latin-1 alphabet, lower part up to 0x7F (which is the equivalent of ASCII-7), within each record if they so choose. UTF8 without BOM is to be used for encoding (unless a different encoding is bilaterally agreed as part of Transliteration).

## Corrections

### Introduction

In case the Competent Authority of a sending jurisdiction becomes aware of inaccurate information, a correction will need to be made. As long as the need for a correction is discovered prior to the filing of the MDR report by the Competent Authority of a sending jurisdiction, no correction, as set out in this section, would be required.

However, in case the need for a correction is discovered after the filing of the MDR report, adjustments to part of the MDR report will need to be made, in accordance with the guidance set out in this section.

In order to facilitate a targeted reporting of corrections, the MDR XML Schema is split into two correctable types, allowing correcting specific parts of the MDR body without needing to resubmit the entire MDR body.

These two correctable types include:

- CorrectableDisclosing\_Type allowing a correction of the information provided on a particular disclosing person
- CorrectableMdrReport\_Type allowing a correction of the information provided on a Reportable Taxpayer, Intermediaries and/or the Structure in relation to a CRS Avoidance Arrangement or Opaque Offshore Structure.

### **Technical Guidance**

This section describes how to make automatic corrections by sending a file of corrected data that can be processed in the same systems as the original data that was received. Reference to corrections also includes deletion of records.

In order to identify the elements to correct, the top-level elements Disclosing and MdrReport include an element of the DocSpec\_Type, which contains the necessary information for corrections.

For the MDR XML Schema, the term record refers to the two correctable records (Disclosing and MdrReport). The correctable records contain a DocSpec (and a DocRefID), thus allowing for future corrections.

#### **DocSpec Type**

<b>Element</b>	<b>Attribute</b>	<b>Size</b>	<b>Input Type</b>	<b>Requirement</b>
DocSpec			mdr:DocSpec_Type	Validation

DocSpec identifies the particular record within the MDR message being transmitted. It permits the identification of record requiring correction. The DocSpec element is composed of the following:

<b>Element</b>	<b>Attribute</b>	<b>Size</b>	<b>Input Type</b>	<b>Requirement</b>
DocTypeIndic			stf:OECDDocTypeIndic_EnumType	Validation

This element specifies the type of data being submitted. Allowable entries are:

- OECD0 = Resent Data
- OECD1 = New Data
- OECD2 = Corrected Data
- OECD3 = Deletion of Data
- OECD10 = Resent Test Data
- OECD11 = New Test Data
- OECD12 = Corrected Test Data
- OECD13 = Deletion of Test Data

A message can either contain new records (OECD1 and/or OECD0) or corrections and/or deletions (OECD2, OECD3 and/or OECD0), but must not contain a mixture of both.

The resend option (OECD 0) can only be used for the Disclosing element when the Disclosing element has already been sent.

The resend option (OECD 0) can be used in the two following cases:

- New data: in case new information is provided in the MdrReport element and the Disclosing element has already been sent.

- Correction: in case the MdrReport element is corrected and the Disclosing element has already been sent and Disclosing element does not need to be corrected.

The MdrReport can only be omitted when the Disclosing element is being corrected and no data needs to be corrected on the MdrReport.

When the Disclosing element is being deleted, then the related MdrReport must also be deleted (or vice-versa, when the MdrReport is being deleted, then the related Disclosing must also be deleted).

The codes OECD10 through OECD13 should only be used in the CTS testing environment or in another agreed testing environment, as to avoid that test data becomes mingled with ‘live’ data.

Element	Attribute	Size	Input Type	Requirement
DocRefID		1 to 200 characters	mdr:StringMin1Max200_Type	Validation

The DocRefID is a unique identifier for the document (i.e. one record and all its children data elements). A correction (or deletion) must have a new unique DocRefID for future reference.

Element	Attribute	Size	Input Type	Requirement
CorrDocRefID		1 to 200 characters	mdr:StringMin1Max200_Type	Optional

The CorrDocRefID references the DocRefID of the element to be corrected or deleted. It must always refer to the latest reference of the record (DocRefID) that was sent.

In this way, a series of corrections can be handled as each correction completely replaces the previous version. The MDR Correction examples show how this works in practice.

### Uniqueness of MessageRefID and DocRefID

In order to ensure that a message and a record can be identified and corrected, the MessageRefID and DocRefID must be unique in space and time (i.e. there must be no other message or record in existence that has the same reference identifier).

The MessageRefID identifier can contain whatever information the sender uses to allow identification of the particular report (i.e. of a particular Message) but must start with the sending country code as the first element for Competent Authority to Competent Authority transmission, then the receiving country code before a unique identifier.

e.g. CALU123456789

This MessageRefID indicates that Canada is the country of the sending Competent Authority, the receiving Competent Authority is Luxembourg and that the unique identifier is “123456789”.

The unique identifier in the DocRefID is used by the sending Competent Authority to identify a unique record and is composed of the country code of the sending jurisdiction, before a unique identifier.

e.g. CA286abc123xyz

This DocRefID indicates that Canada is the country of the sending Competent Authority, and the unique identifier is “286abc123xyz”.

## MessageSpec, Corrections and Cancellations

Correction messages must have their own unique MessageRefID so they can also be corrected in the future. There is no equivalent for the DocSpec type when it comes to messages as a whole.

To cancel a complete message, a correction message should be sent deleting all records of the erroneous message in these instances.

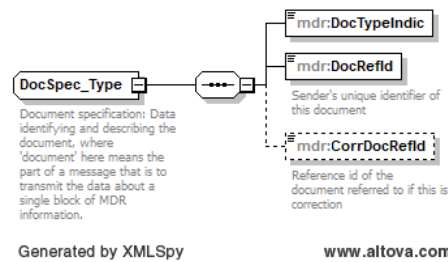

The following examples show how the DocSpec\_Type elements are used to correct one or multiple parts of data previously sent.

When correcting a record, we will always correct the whole record (with all its sub-elements). The following correction examples will provide a few examples of this concept.

### MDR Correction examples

Note: In these examples, the sender (France) has decided to include the year the data was sent in the unique identifier of its DocRefID and MessageRefID. This way, the sender can easily change the structure of these IDs in the next years and still be assured that these IDs are unique in time and space.

**First example:** a correction is made in relation to the CRS avoidance to the Structure element, which is located under the MdrReport correctable element. The correction is to be made in the Summary field.

The correction file is sent from France (containing only corrections, not a mix of new and corrected data).

MessageRefID: FRCA2018FranceNationalPart00001.

For a correction, the whole record is corrected (with all its sub-elements).

For this example, the whole MdrReport record must be resubmitted with all its child elements, even if only the Summary field will be changed. Since the Disclosing record does not need to be updated, it will be resent (with OECD0).

**First example:**

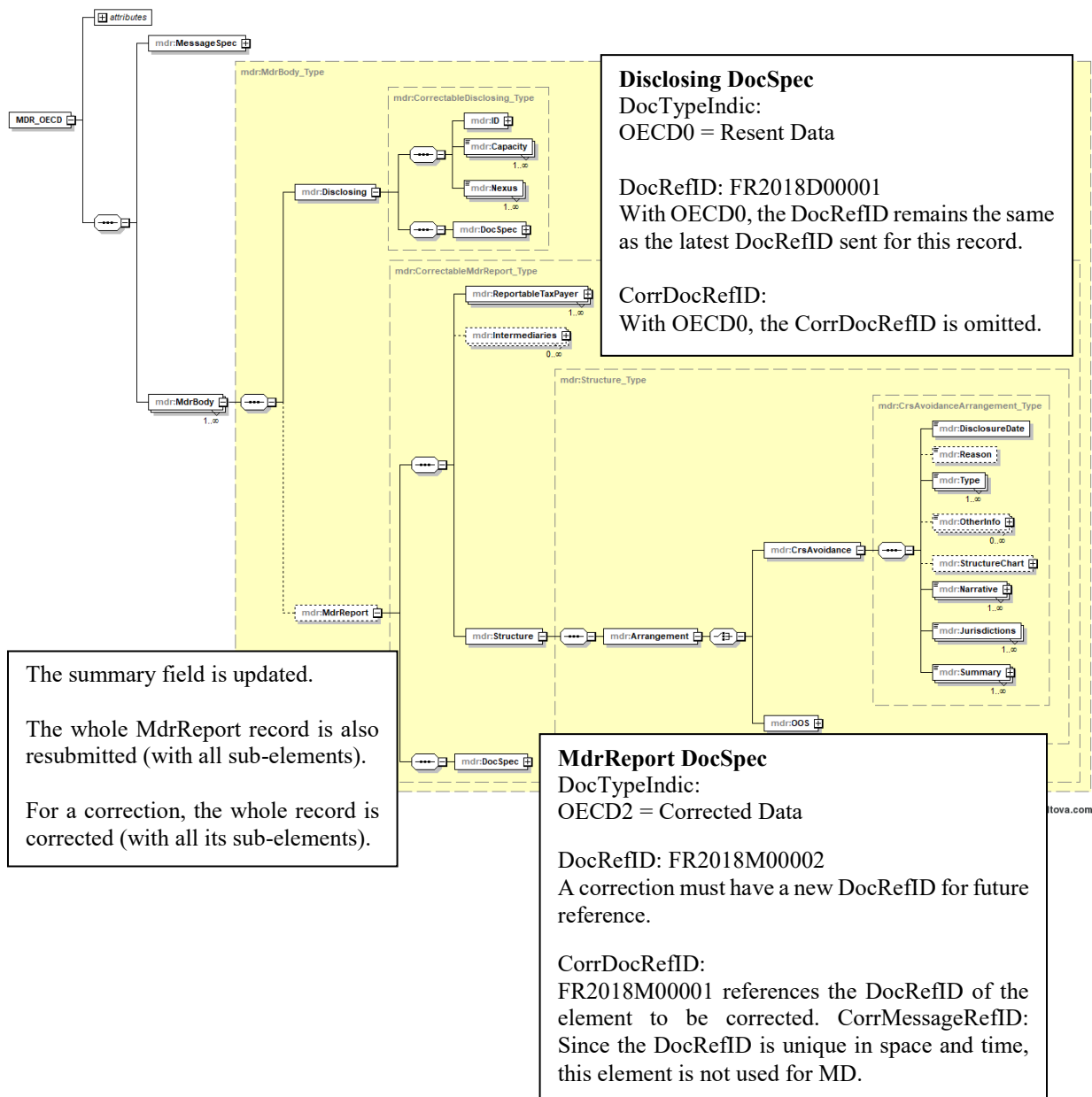

**Second example:** a correction is made regarding the Disclosing and Reportable Taxpayer elements.

For the Disclosing element, the Capacity field must be updated. For the Reportable Taxpayer element (under the MdrReport), the address of the Individual Tax Payer must be updated.

For a correction, the whole record is corrected with all sub-elements (even if there is only one sub-element that has been updated). This is true for all correctable records (Disclosing and MdrReport).

Thus, in our second example, the two records (Disclosing and MdrReport) will be corrected by resubmitting the whole record (with all their sub-elements).

MessageRefID: FRCA2018FranceNationalPart00002.

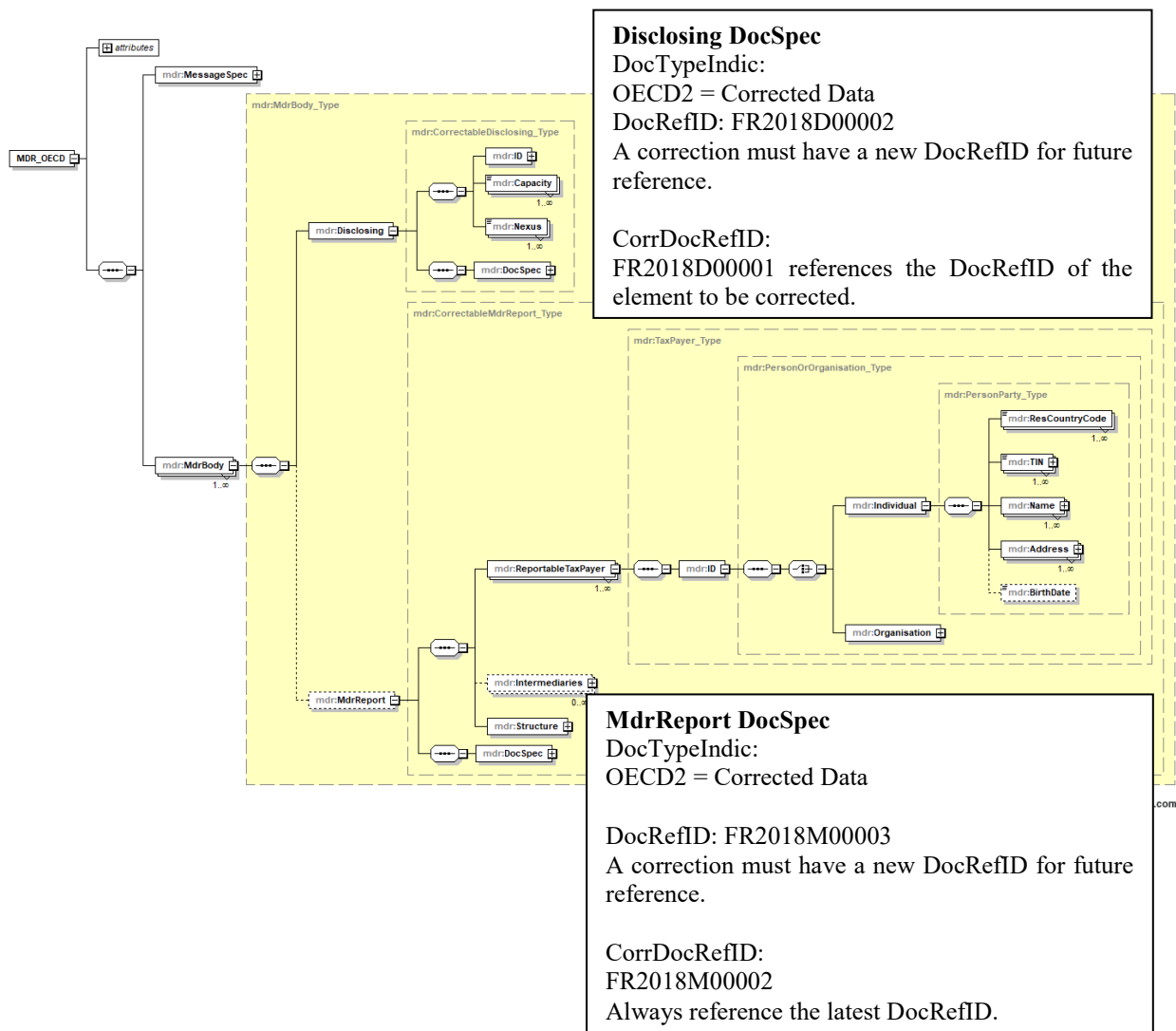



**Third example:** Adding a new Intermediary (with the Disclosing record remaining unaltered)

Even if we are only adding a new Intermediary, the whole MdrReport record will be corrected with all its sub-elements:

Reportable Tax Payer

- Intermediaries (which will include the existing Intermediaries and the new Intermediary)
- Structure

Since an MdrReport is being corrected for an unchanged Disclosing record, we will be using the Resend option (OECD0) on the Disclosing record.

MessageRefID: FRCA2018FranceNationalPart00003.

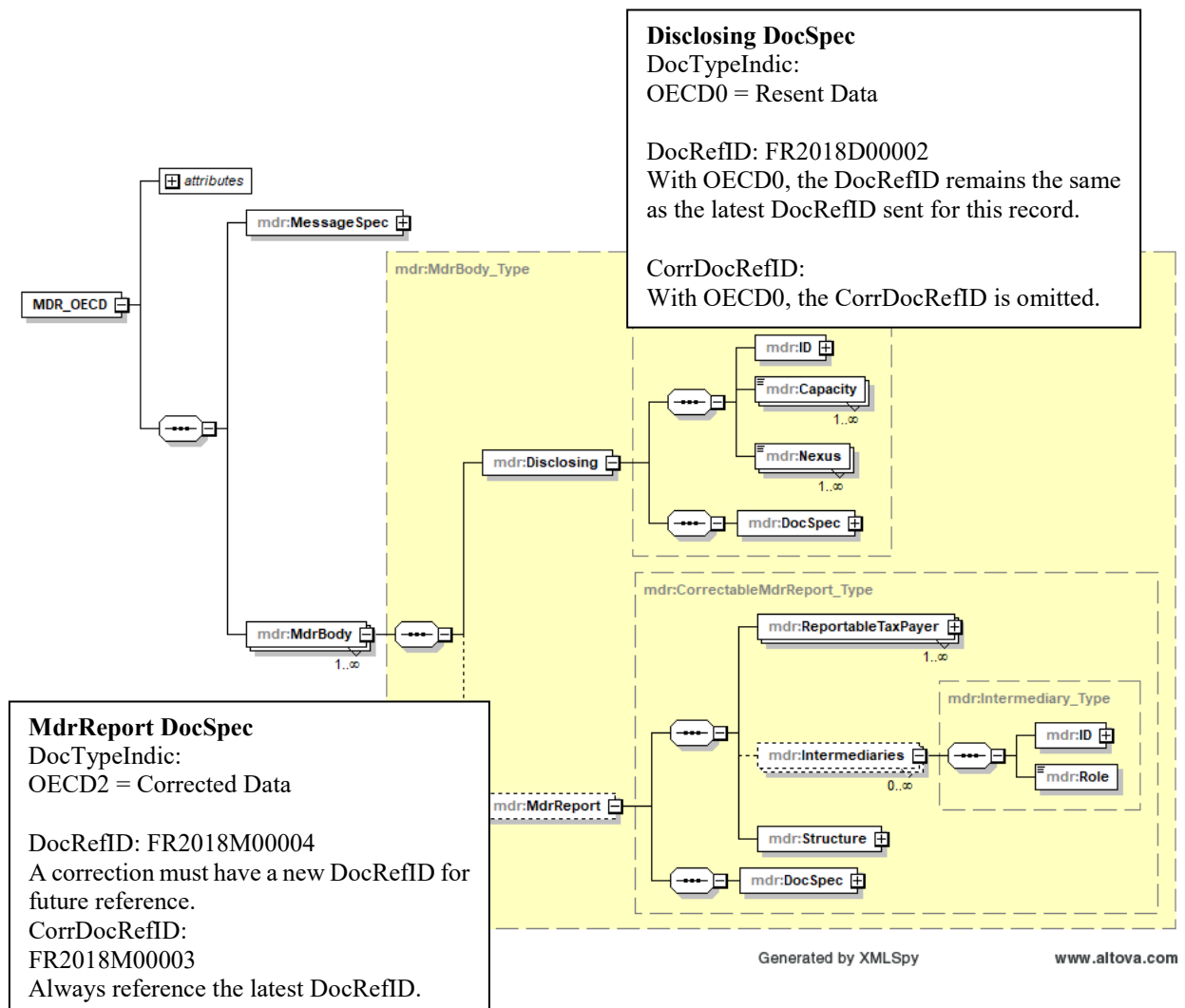

**Fourth example:** Adding a new child to the Structure Chart

Even if only one child needs to be added to the Structure Chart, the whole MdrReport record will be corrected with all its sub-elements:

- Reportable Tax Payer
- Intermediaries
- Structure (with all existing sub-elements and with the new child in the Structure Chart)

Again, the Disclosing record will be resent (with OECD0). All its sub-elements will also be resent since the whole record is resent with OECD0.

MessageRefID: FRCA2018FranceNationalPart00004.

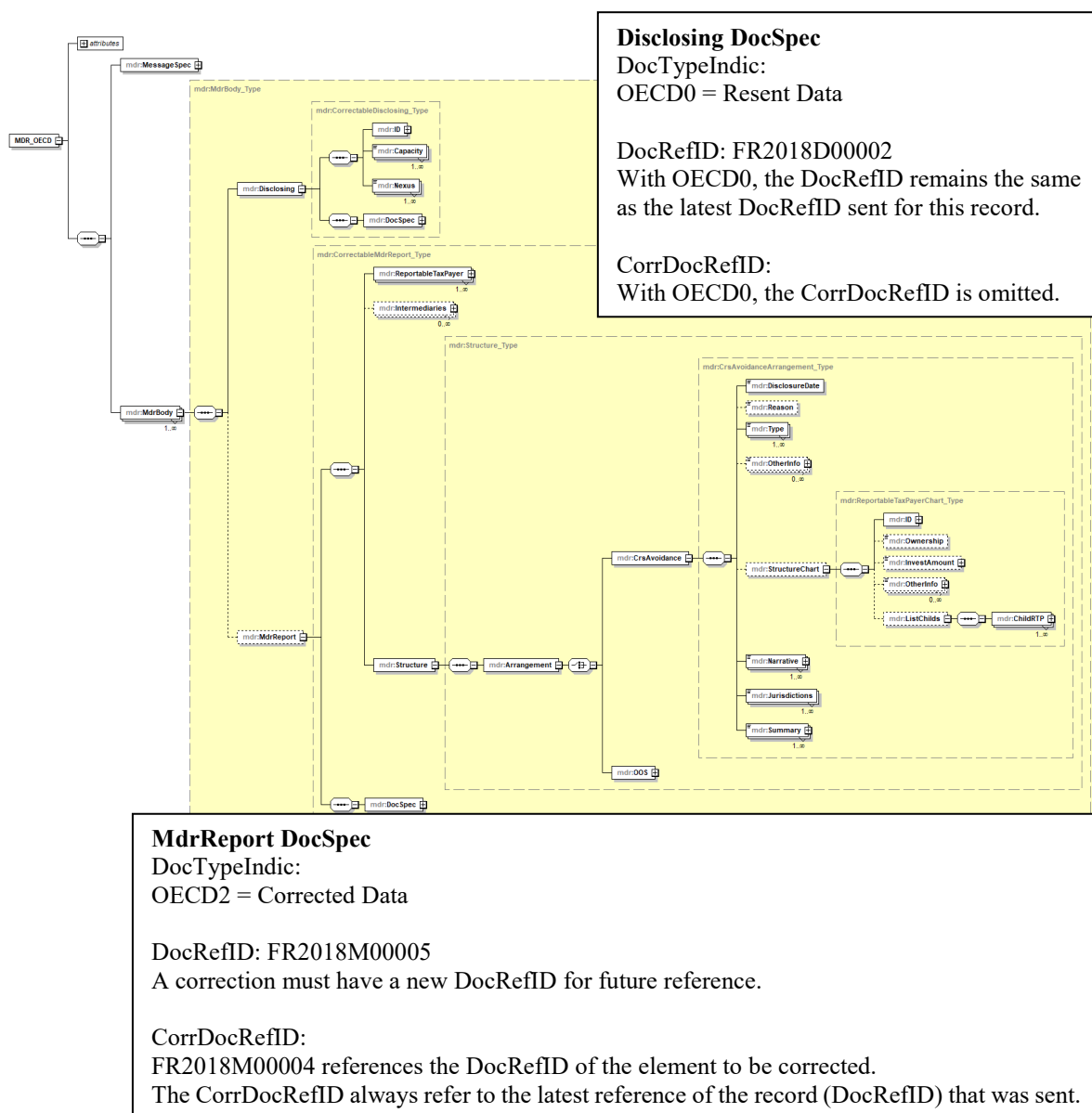

**Fifth example:** Correcting only the Disclosing record

A new Capacity must be added for the Disclosing record (the Capacity is a repeatable element). No data needs to be corrected for the MdrReport.

Even if only one Capacity value needs to be added to the Disclosing record, the whole Disclosing record will be corrected with all its sub-elements:

- ID
- Capacity (with all previous Capacity values and including the new Capacity value)
- Nexus

Since no data needs to be corrected for the MdrReport, the MdrReport will be omitted.

MessageRefID: FRCA2018FranceNationalPart00005.

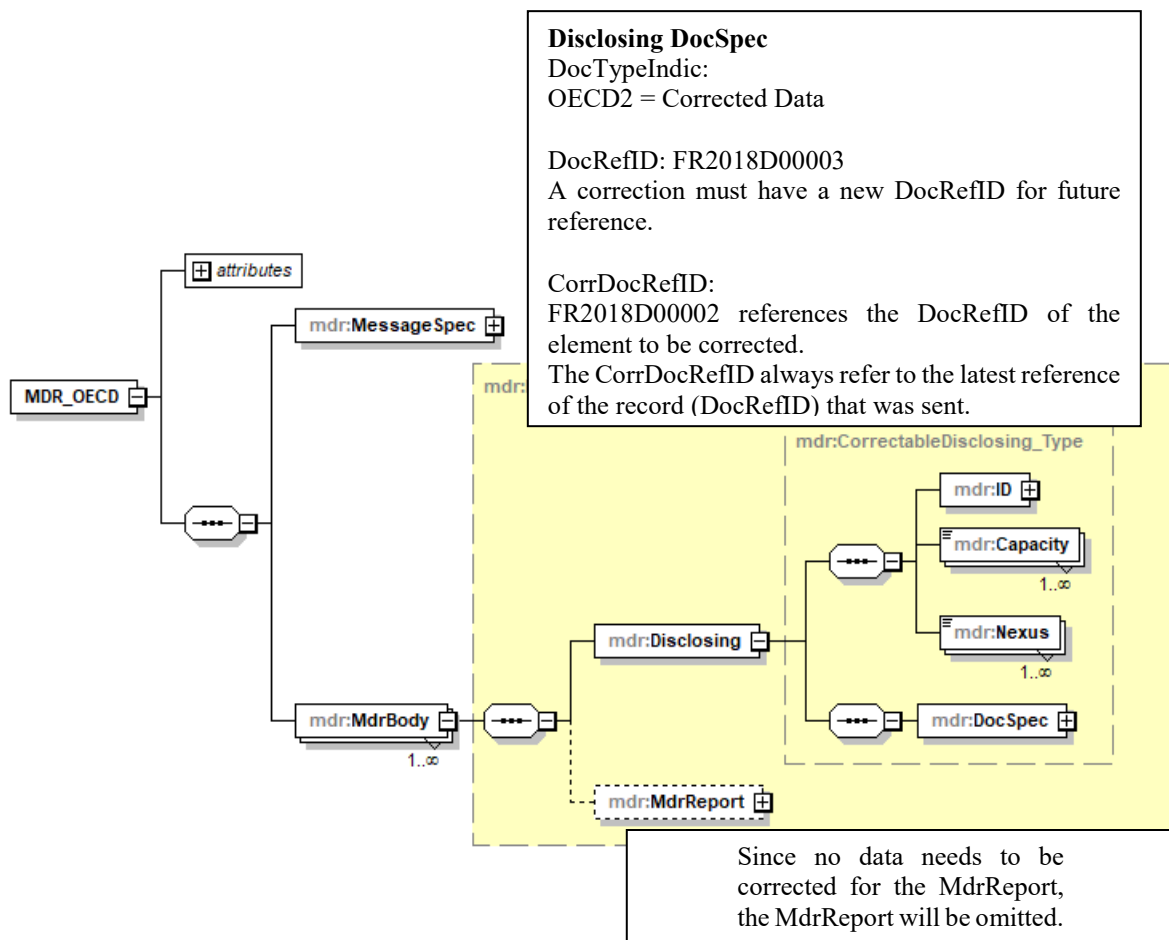

## Appendix A. MDR XML Schema Diagrams

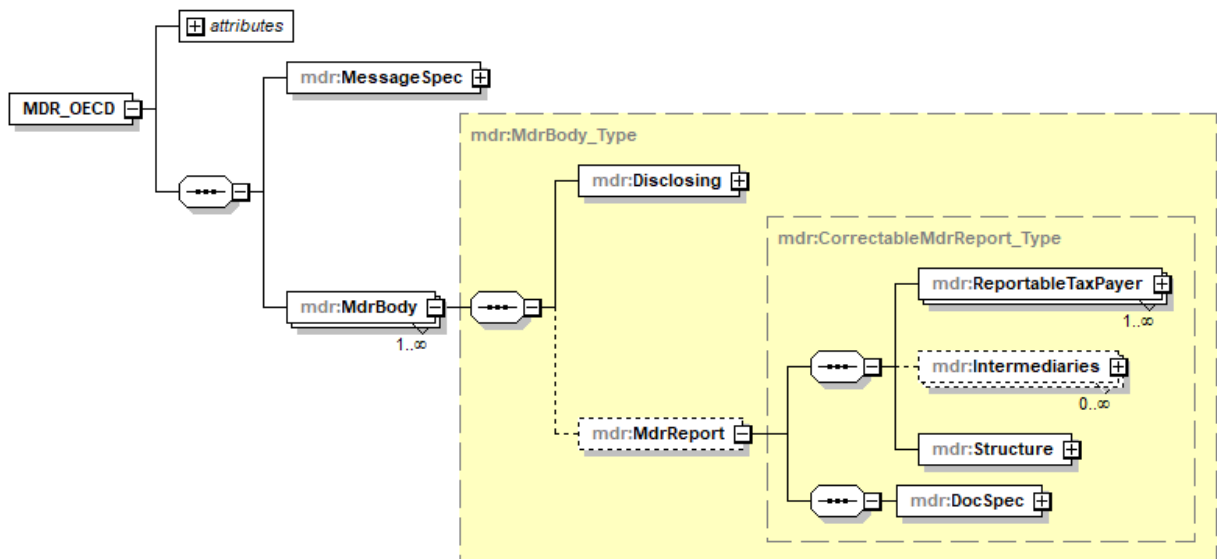

Generated by XMLSpy

www.altova.com

## Message Header

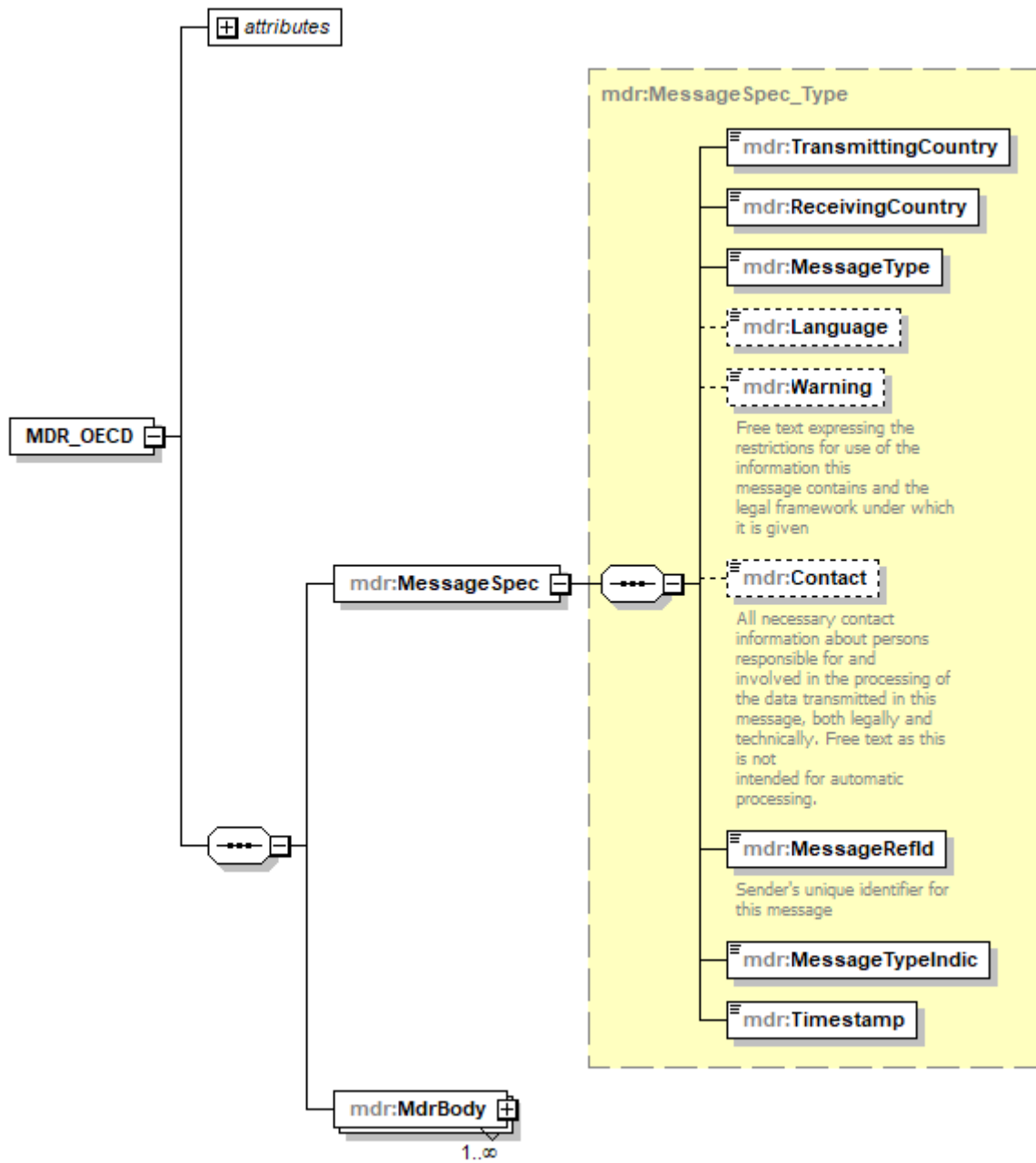

Generated by XMLSpy

www.altova.com

*For practical reasons, the Language list is based on the ISO 639-1 language list which is currently used by banks and other financial institutions, and hence by tax administrations. The use of this list does not imply the expression by the OECD of any opinion whatsoever concerning the legal status of the territories listed. Its content is without prejudice to the status of or sovereignty over any territory, to the delimitation of international frontiers and boundaries and to the name of any territory, city or area.*

## Disclosing

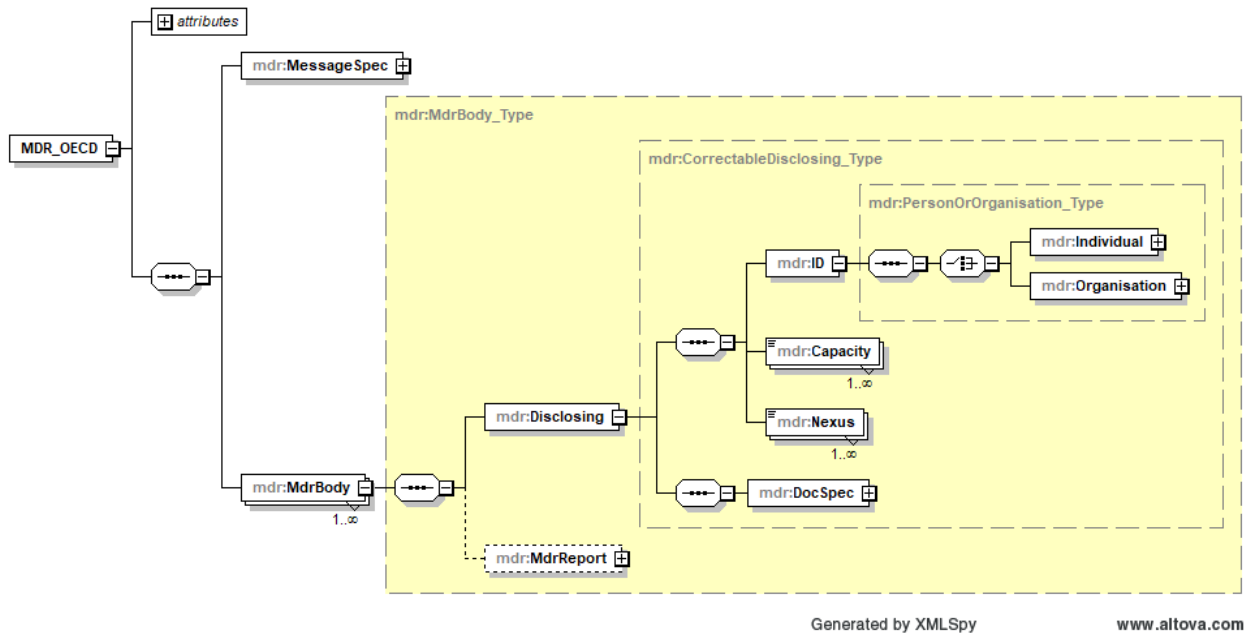

## Reportable Taxpayer and Intermediaries

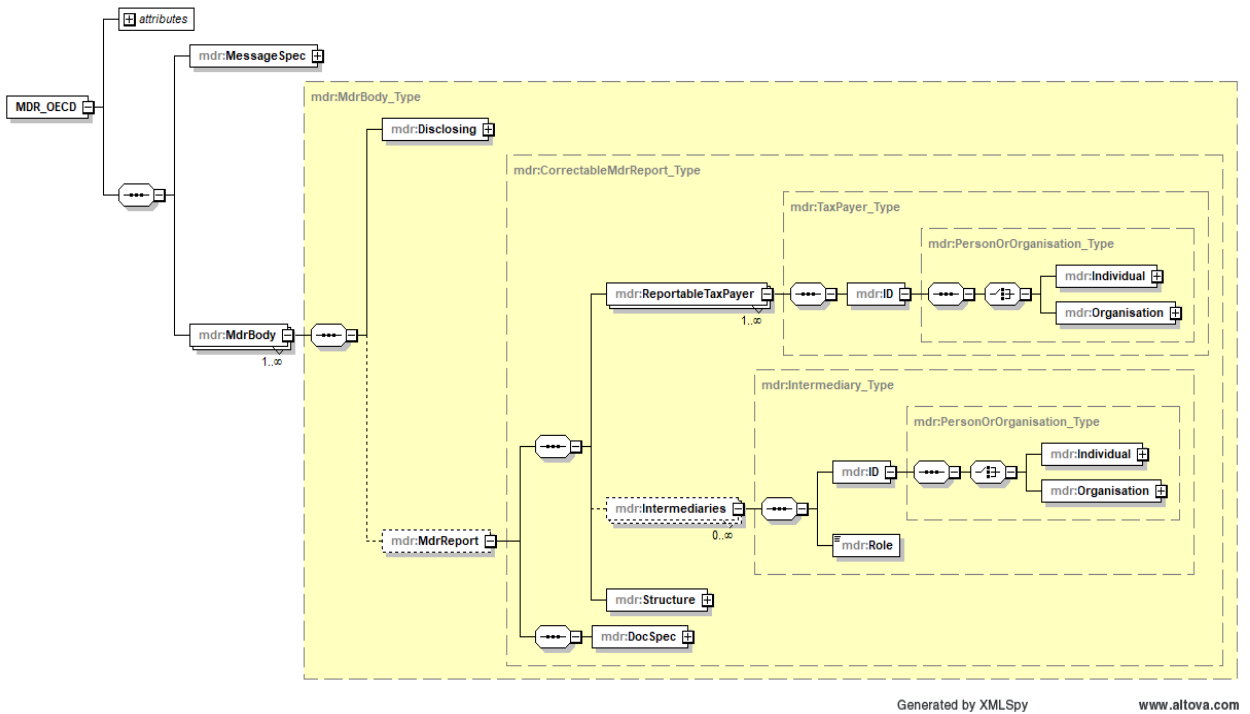



## Opaque Offshore Structure

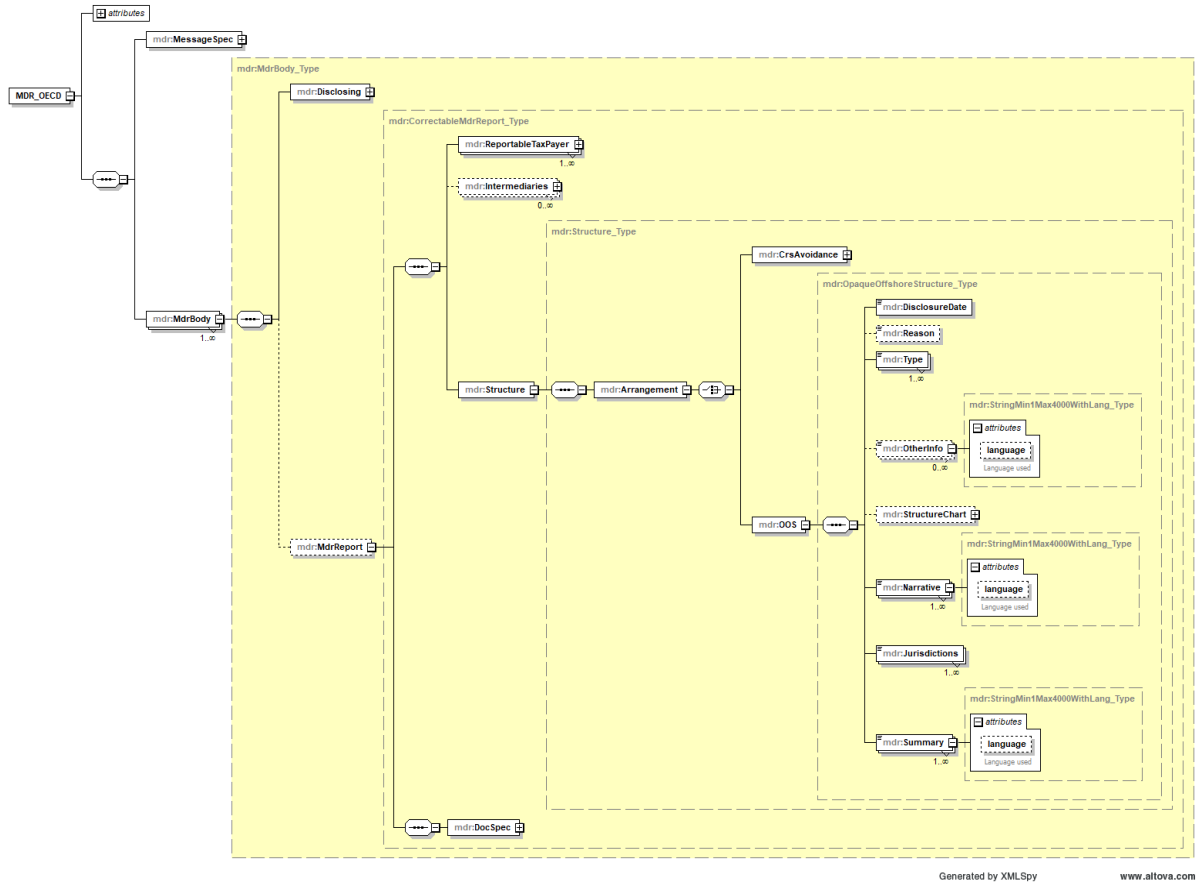



### Structure Chart (ReportableTaxPayerChart\_Type)

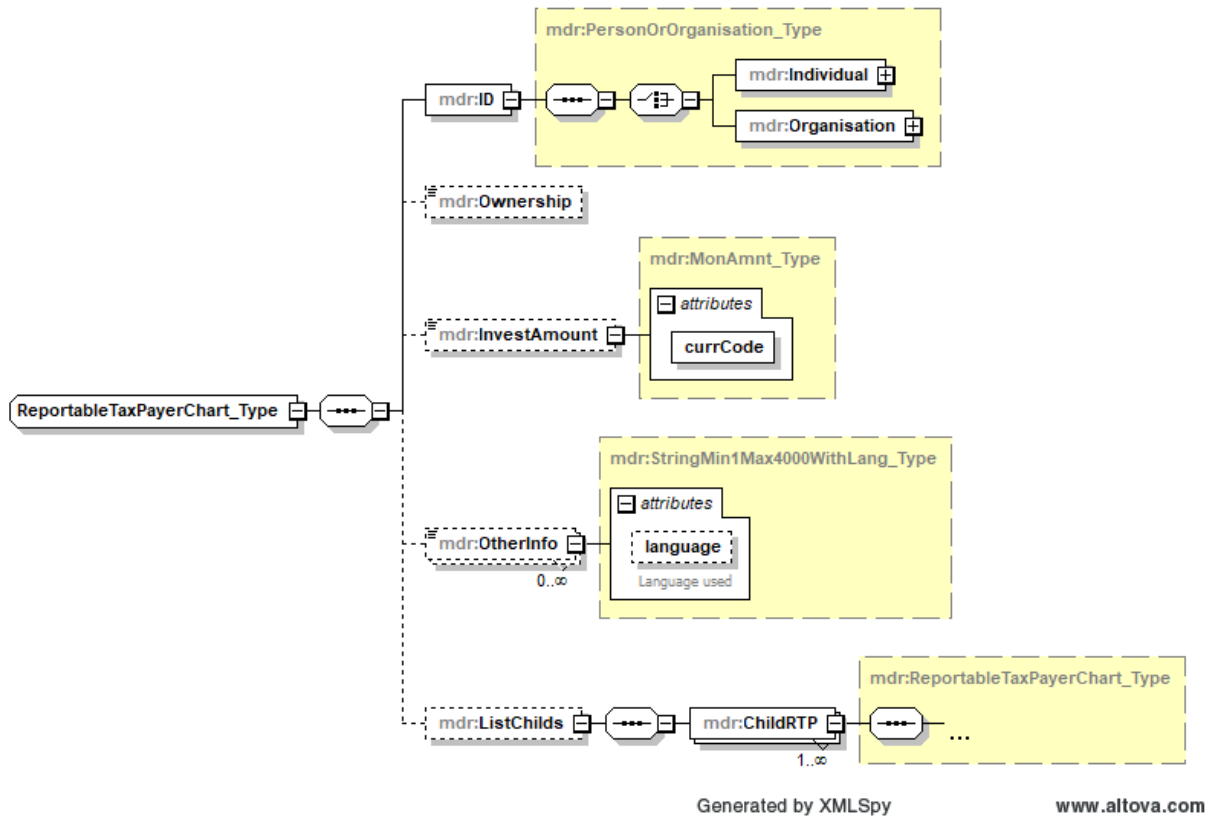

## PersonParty\_Type

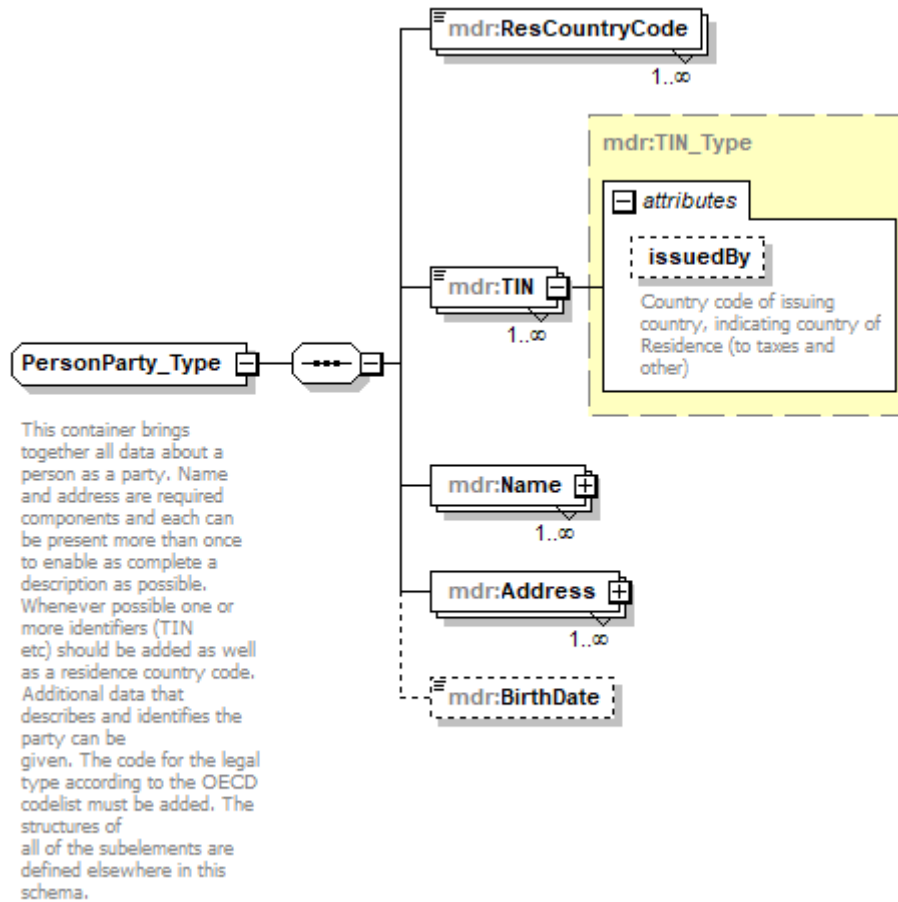

Generated by XMLSpy

www.altova.com

## NamePerson\_Type

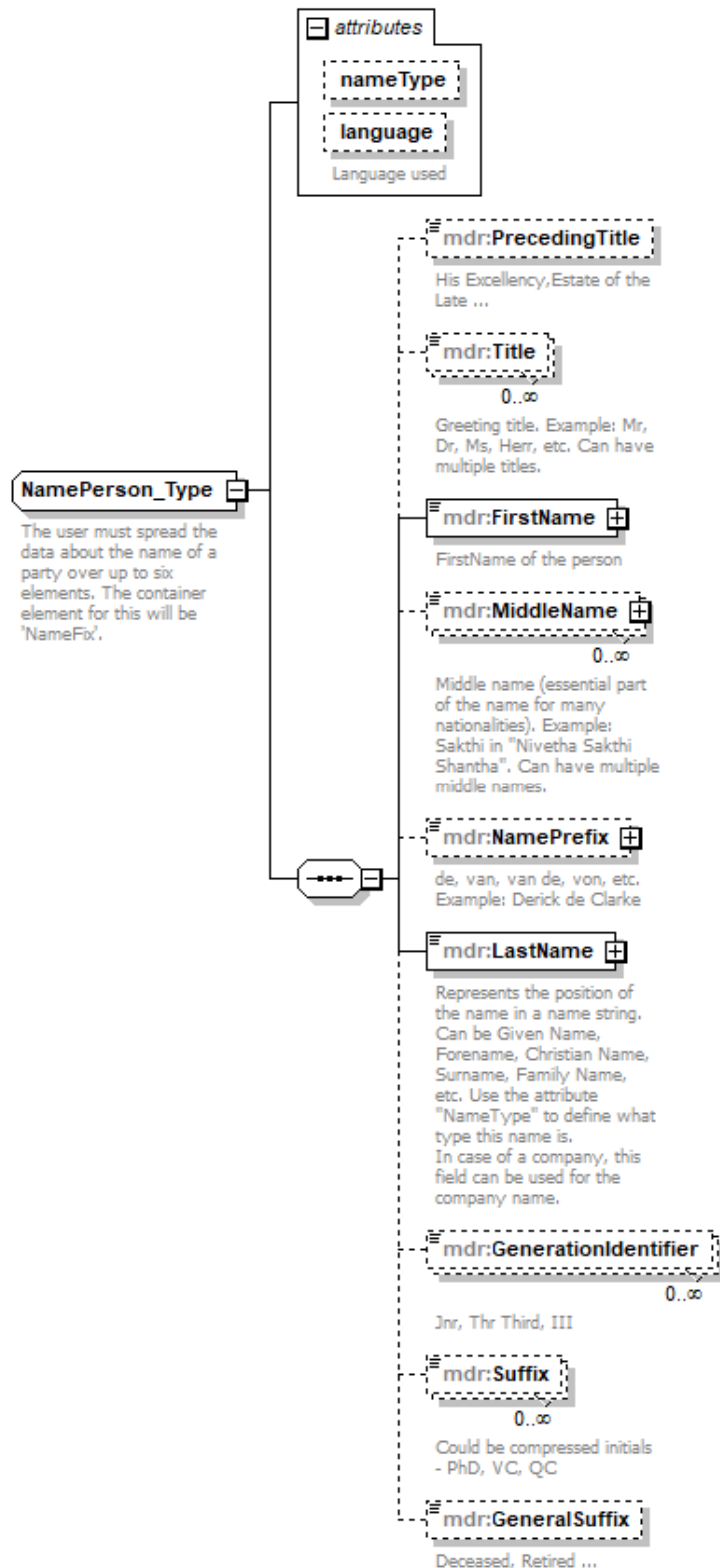

Generated by XMLSpy

www.altova.com

## Address\_Type

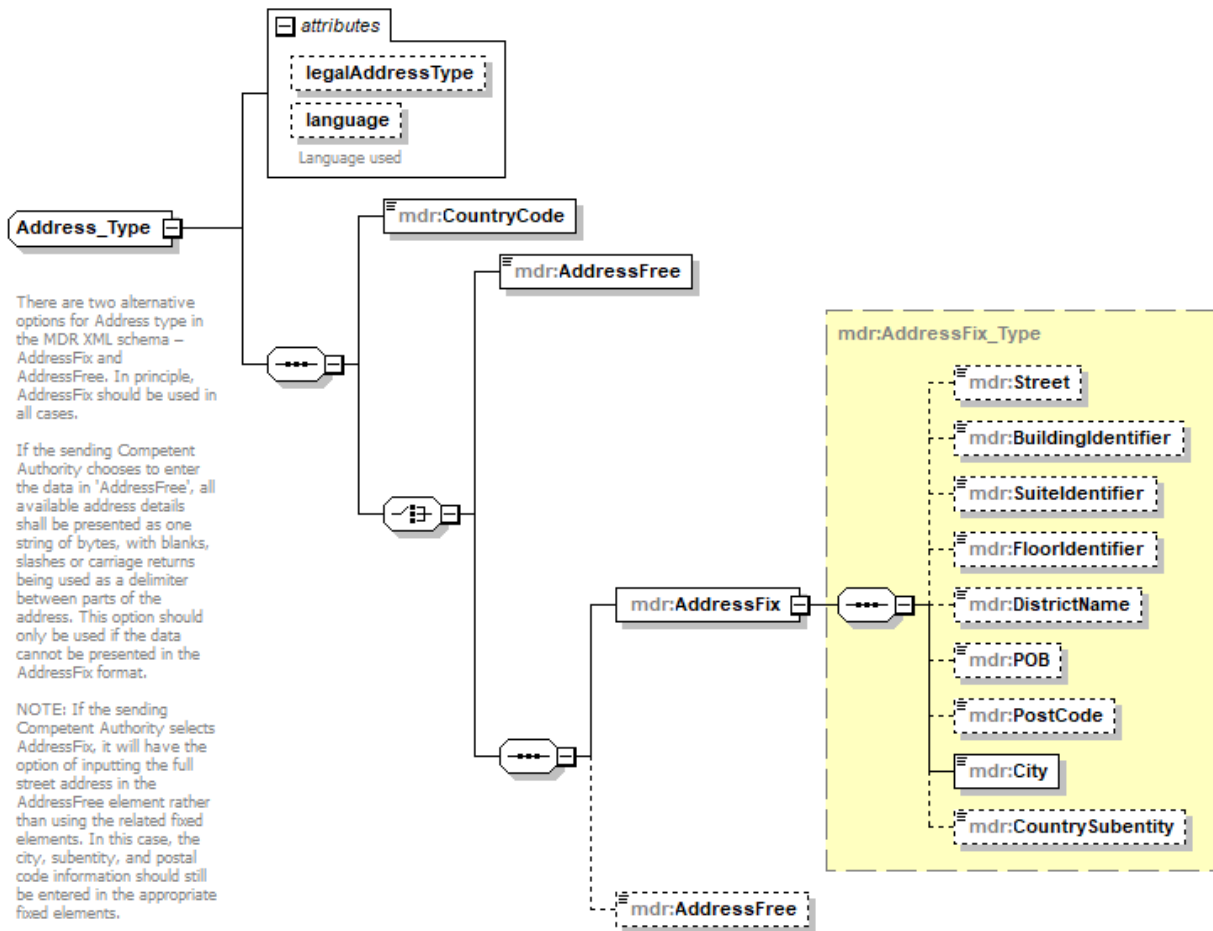

Generated by XMLSpy

www.altova.com

## OrganisationParty\_Type

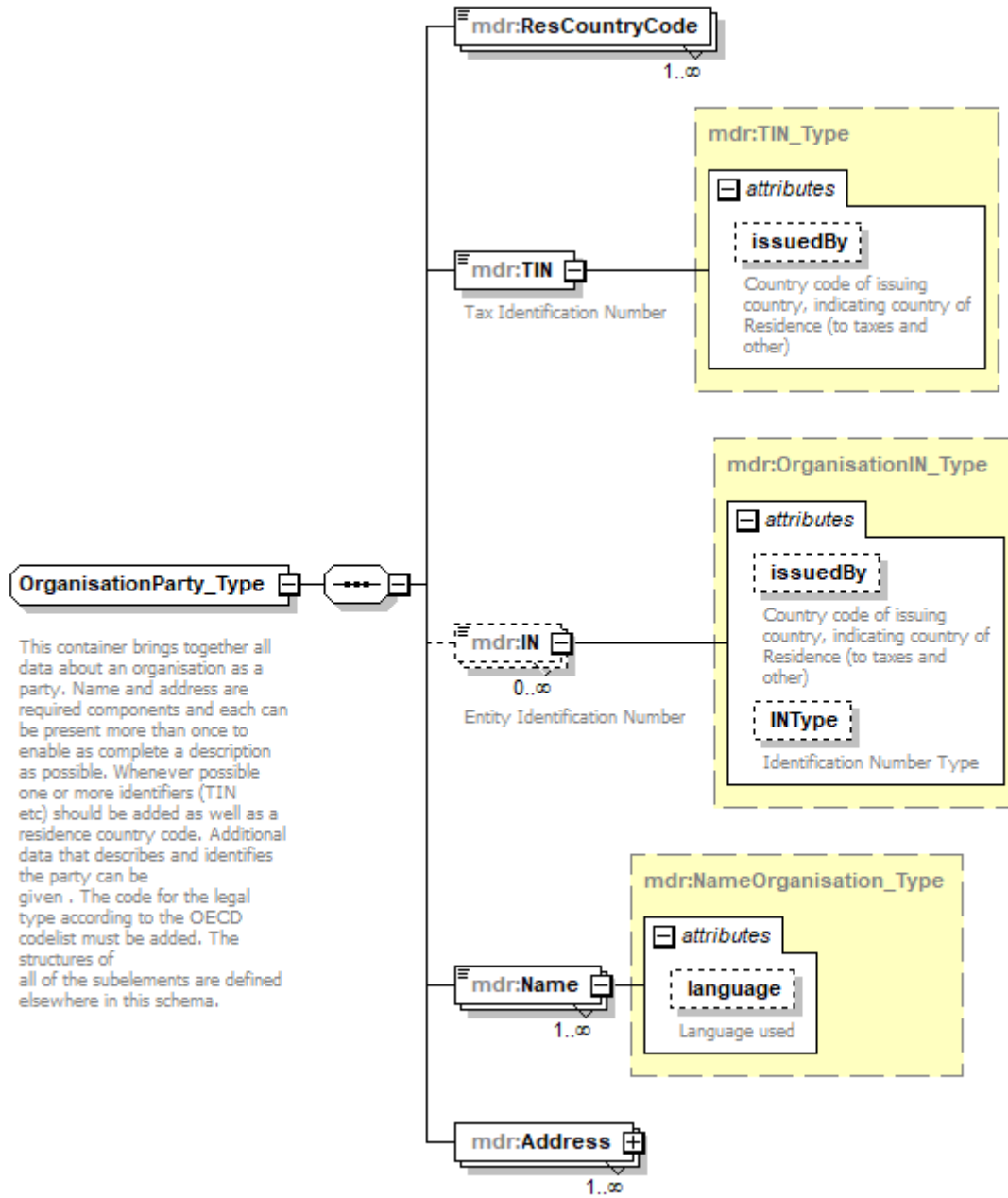

Generated by XMLSpy

www.altova.com

*For practical reasons, the ResCountryCode list is based on the ISO 3166-1 country list which is currently used by banks and other financial institutions, and hence by tax administrations. The use of this list does not imply the expression by the OECD of any opinion whatsoever concerning the legal status of the territories listed. Its content is without prejudice to the status of or sovereignty over any territory, to the delimitation of international frontiers and boundaries and to the name of any territory, city or area.*

## Person or Organisation Type

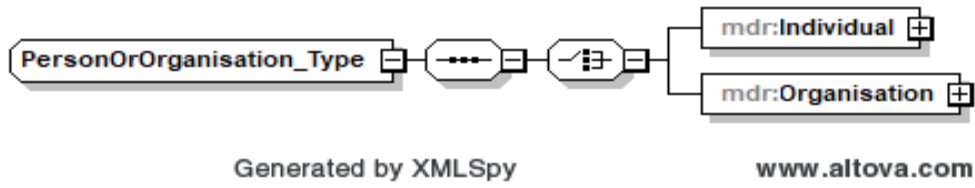

## Appendix B. Glossary of Namespaces

### MDR XML Schema Namespaces

Namespace	Description	Filename
mdr	MDR types	MdrXML_v1.0.xsd
stf	OECD Common types	OecdMdrTypes_v1.0.xsd
iso	ISO types (Country, Currency & Language codes)	IsoMdrTypes_v1.0.xsd



**For more information:**

---

 [ctp.contact@oecd.org](mailto:ctp.contact@oecd.org)

---

 <http://oe.cd/crs>

---

 [@OECDtax](https://twitter.com/OECDtax)

---